

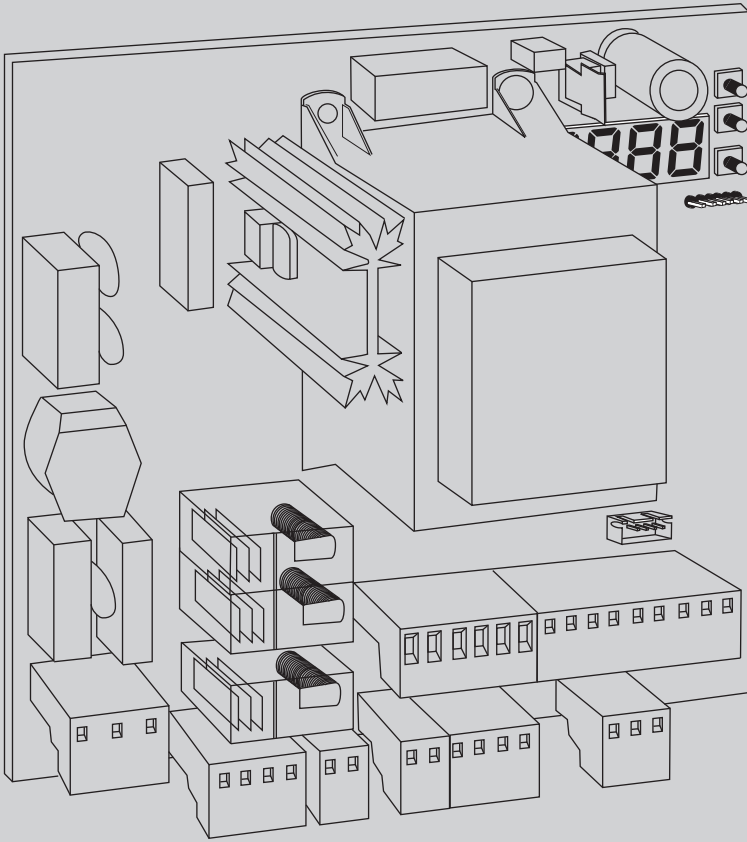

D811893 00100_02 04-12-12

QUADRO COMANDO
CONTROL PANEL
CENTRALE DE COMMANDE
SELBSTÜBERWACHENDE STEUERUNG
CUADRO DE MANDOS
BEDIENINGSPANEEL



ISTRUZIONI DI INSTALLAZIONE
INSTALLATION MANUAL
INSTRUCTIONS D'INSTALLATION
MONTAGEANLEITUNG
INSTRUCCIONES DE INSTALACION
INSTALLATIEVOORSCHRIFTEN

LEO B CBB 3 230 L02
LEO B CBB 3 230 L04
LEO B CBB 3 120 F02
LEO B CBB 3 120 F04

U-link



AZIENDA CON SISTEMA DI GESTIONE
INTEGRATO CERTIFICATO DA DNV
= UNI EN ISO 9001:2008 =
UNI EN ISO 14001:2004

INSTALLAZIONE VELOCE-QUICK INSTALLATION-INSTALLATION RAPIDE SCHNELLINSTALLATION-INSTALACIÓN RÁPIDA - SNELLE INSTALLATIE

D811893 00100_02

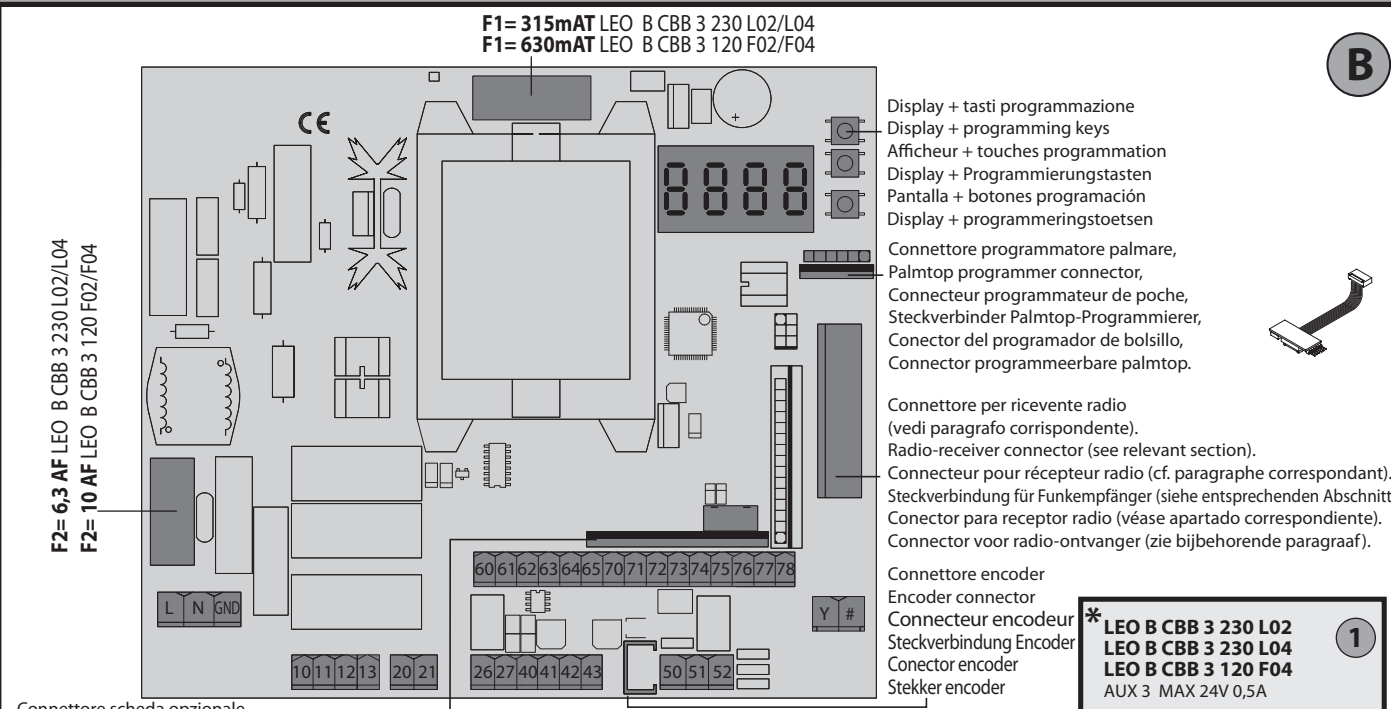
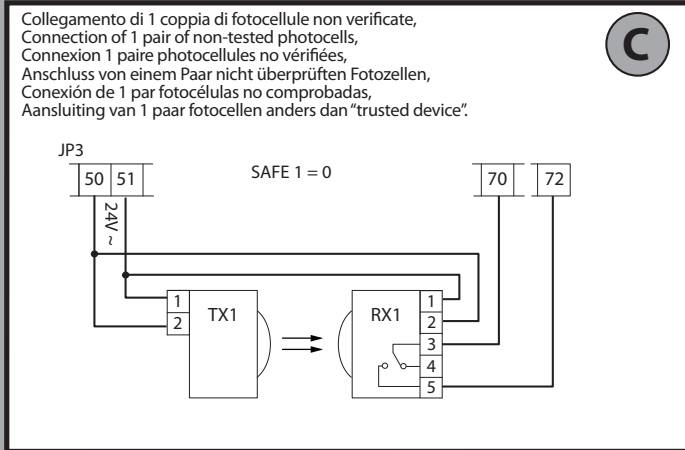
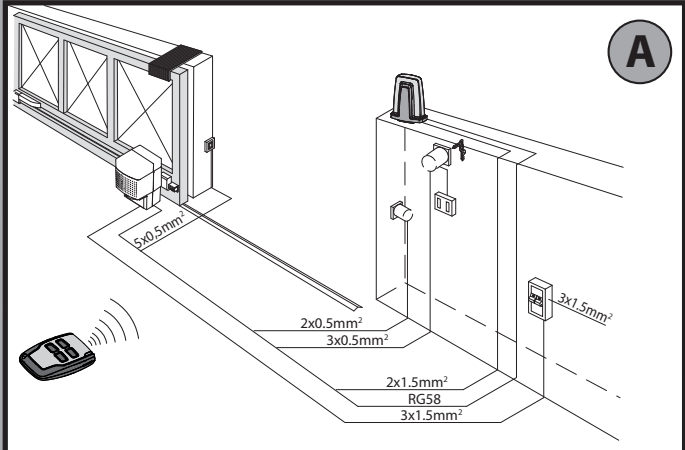

- Display + tasti programmazione / Display + programming keys / Afficheur + touches programmation / Display + Programmierungstasten / Pantalla + botones programación / Display + programmeringstoetsen
- Connettore programmatore palmare, Palmtop programmer connector, Connecteur programmeur de poche, Steckverbinder Palmtop-Programmierer, Conector del programador de bolsillo, Connector programmeerbare palmtop.
- Connettore per ricevente radio (vedi paragrafo corrispondente). / Radio-receiver connector (see relevant section). / Connecteur pour récepteur radio (cf. paragraphe correspondant). / Steckverbindung für Funkempfänger (siehe entsprechenden Abschnitt). / Conector para receptor radio (véase apartado correspondiente). / Connector voor radio-ontvanger (zie bijbehorende paragraaf).
- Connettore encoder / Encoder connector / Connecteur encodeur / Steckverbindung Encoder / Conector encoder / Stekker encoder

Connettore scheda opzionale / Optional board connector / Connecteur carte facultative / Steckverbinder Zusatzkarte / Conector de la tarjeta opcional / Connector optionele kaart

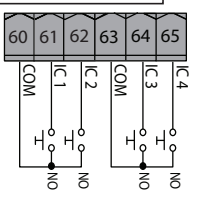

Comandi / Commands / Commandes / Bedienelemente / Mandos / Commando's

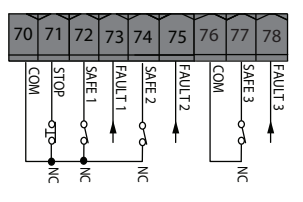

Sicurezze / Safety devices / Sécurités / Sicherheitsvorrichtungen / Dispositivos de seguridad / Veiligheden

M	B	N
MARRONE	BLU	NERO
BROWN	BLUE	BLACK
MARRON	BLEU	NOIR
BRAUN	BLAU	SCHWARZ
MARRÓN	AZUL	NEGRO
BRUIN	BLAUW	ZWART

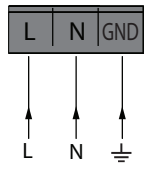

Alimentazione / Power supply / Alimentation / Stromversorgung / Alimentación / Voeding

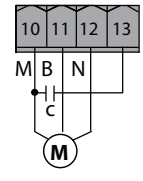

Motore / Motor / moteur / Motor / Eindanslag / Motor

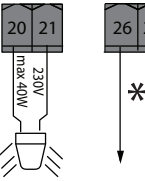

AUX

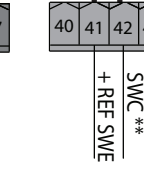

Ingressi finecorsa / Limit switch inputs / Entrées des fins de course / Eingänge Anschlag / Entradas finales de carrera / Ingangen

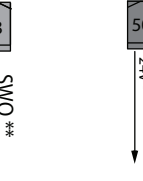

Alimentazione accessori / Accessories power supply / Alimentation des accessoires / Stromversorgung Zubehör / Alimentación accesorios / Voeding accessoires

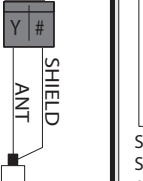
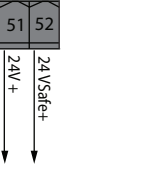

Antenna / Antenne / Antenne / Antenne

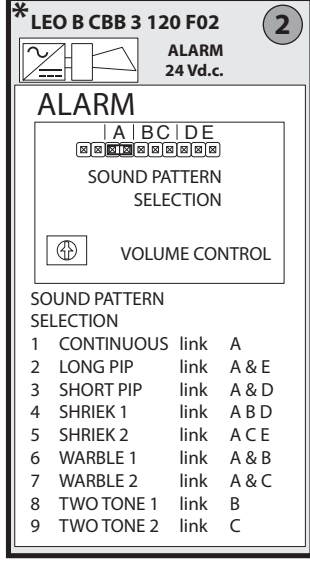
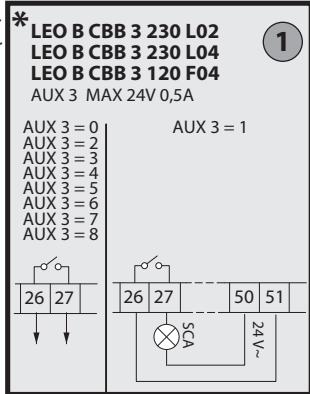

SOUND PATTERN SELECTION

1	CONTINUOUS	link	A
2	LONG PIP	link	A & E
3	SHORT PIP	link	A & D
4	SHRIEK 1	link	A B D
5	SHRIEK 2	link	A C E
6	WARBLE 1	link	A & B
7	WARBLE 2	link	A & C
8	TWO TONE 1	link	B
9	TWO TONE 2	link	C

**Con logica inversione direzione di apertura = 000 (DIR=DX) / **With reverse logic, opening direction = 000 (DIR=right)
 ** Avec logique inversion direction d'ouverture = 000 (DIR=DRT) / **Mit Inversionslogik Öffnungsrichtung = 000 (DIR=rechts)
 **Con lógica inversión dirección de apertura = 000 (DIR=DER) / **Met logica omkering openingsrichting = 000 (DIR=R)

SIMPLIFIED MENU

DB11893 00100_02

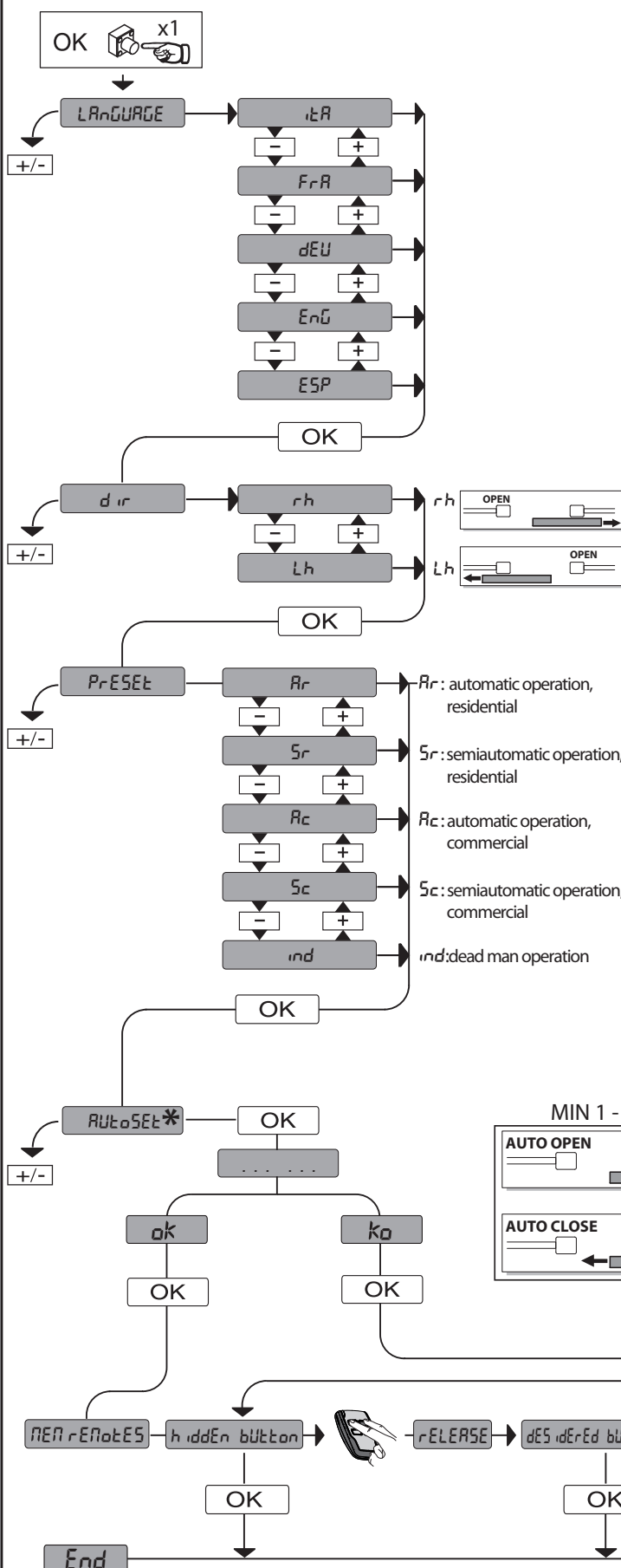

PRESET	DEFAULT	Rr	Sr	Rc	Sc	ind
PARAMETERS						
Opening operation time [s]	300	Set by autose*				
Closing operation time [s]	300	Set by autose*				
Automatic closing time [s]	40	40	40	40	40	40
Time-to-clear traffic light zone [s]	40	40	40	40	40	40
Slow-down distance during opening [%]	30	Set by autose*				
Slow-down distance during closing [%]	30	Set by autose*				
Partial opening	20	20	20	20	20	20
Leaf force during opening [%]	41 (75***)	Set by autose*				
Leaf force during closing [%]	41 (75***)	Set by autose*				
Leaf/leaves force during opening during slow-down[%]	75	Set by autose*				
Leaf/leaves force during closing during slow-down [%]	75	Set by autose*				
Braking[%]	0	Set by autose*				
LOGIC						
Automatic Closing Time	0	1	0	1	0	0
Fast closing	0	0	0	0	0	0
Step-by-step movement	0	1	0	1	0	0
Encoder	2	2	2	2	2	2
Pre-alarm	0	0	0	1	1	0
Deadman	0	0	0	0	0	1
Block pulses during opening	0	0	0	1	1	0
Block pulses during TCA	0	0	0	0	0	0
Block pulses during closing	0	0	0	0	0	0
Open in other direction	0	/	/	/	/	/
SAFE 1	0	/	/	/	/	/
SAFE 2	6	/	/	/	/	/
SAFE 3	2	/	/	/	/	/
IC 1	0	/	/	/	/	/
IC 2	4	/	/	/	/	/
IC 3	2	/	/	/	/	/
IC 4	3	/	/	/	/	/
AUX 3*	0	/	/	/	/	/
Fixed code	0	0	0	0	0	0
Transmitter programming	1	1	1	1	1	1
Serial mode	0	0	0	0	0	0
Address	0	0	0	0	0	0
EXPI1	1	/	/	/	/	/
EXPI2	0	/	/	/	/	/
EXPO1	9	/	/	/	/	/
EXPO2	9	/	/	/	/	/
Traffic light pre-flashing	0	0	0	0	0	0

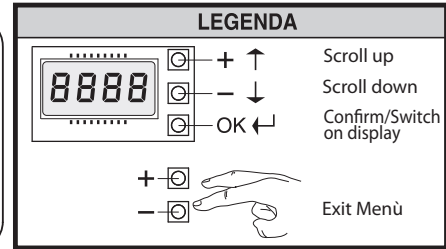
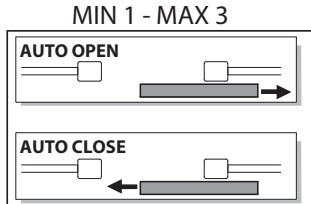

* Only active on LEO B CBB 3 230 L02
 ** Not active on LEO B CBB 3 120 F02
 *** Setup for LEO B CBB 3 120 F02, LEO B CBB 3 230 L04, LEO B CBB 3 120 F04

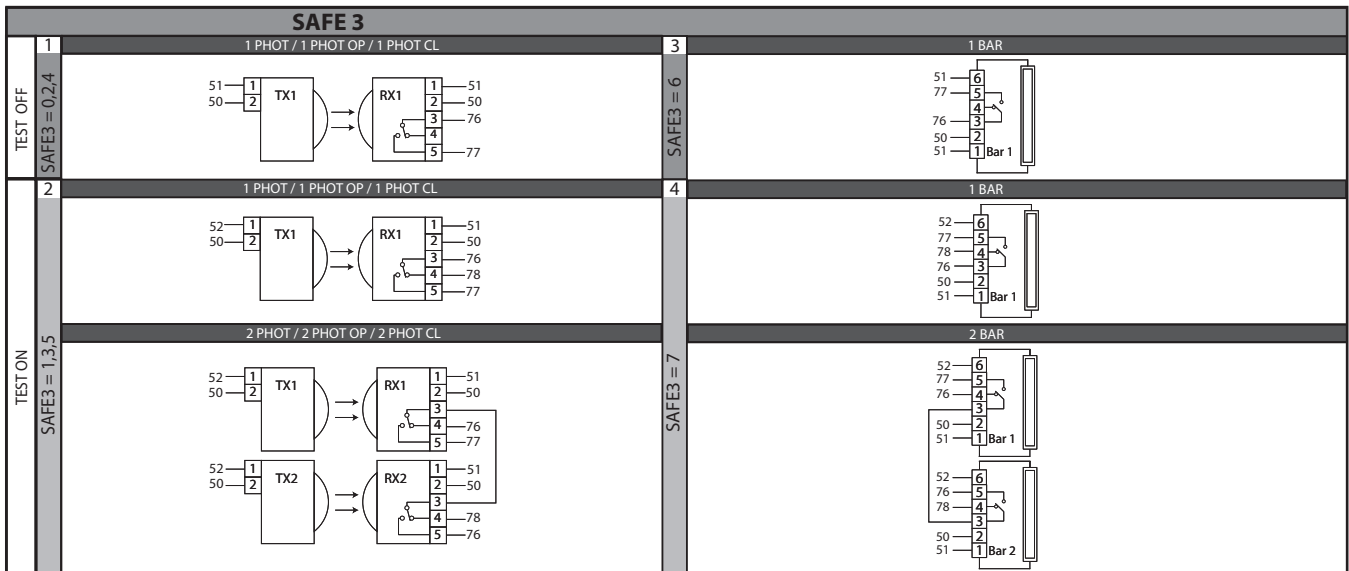
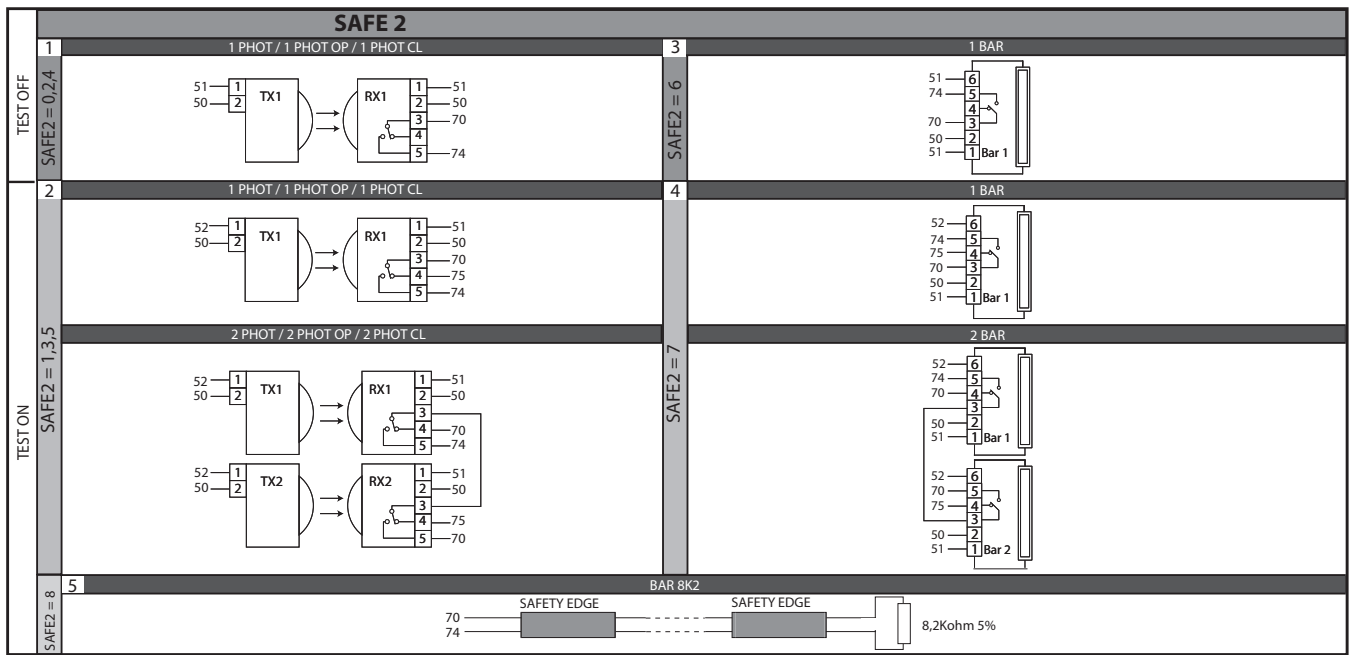
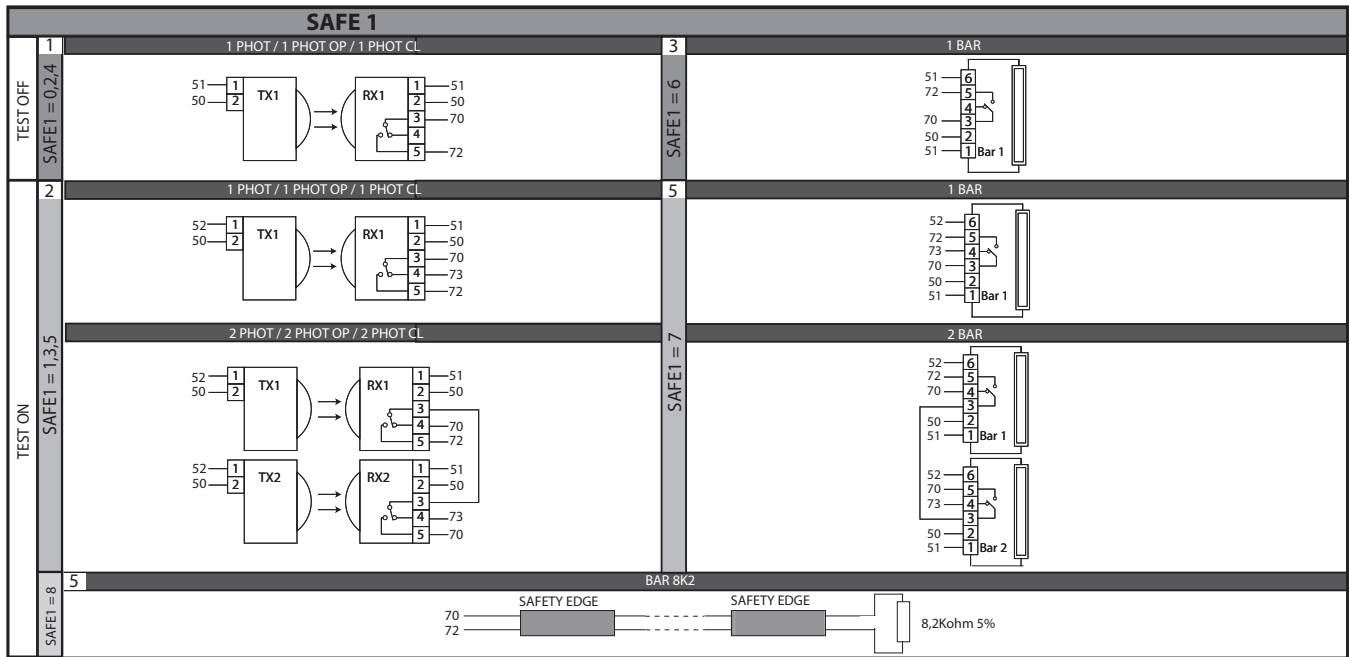
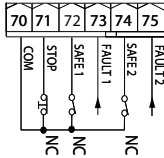
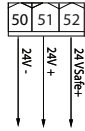

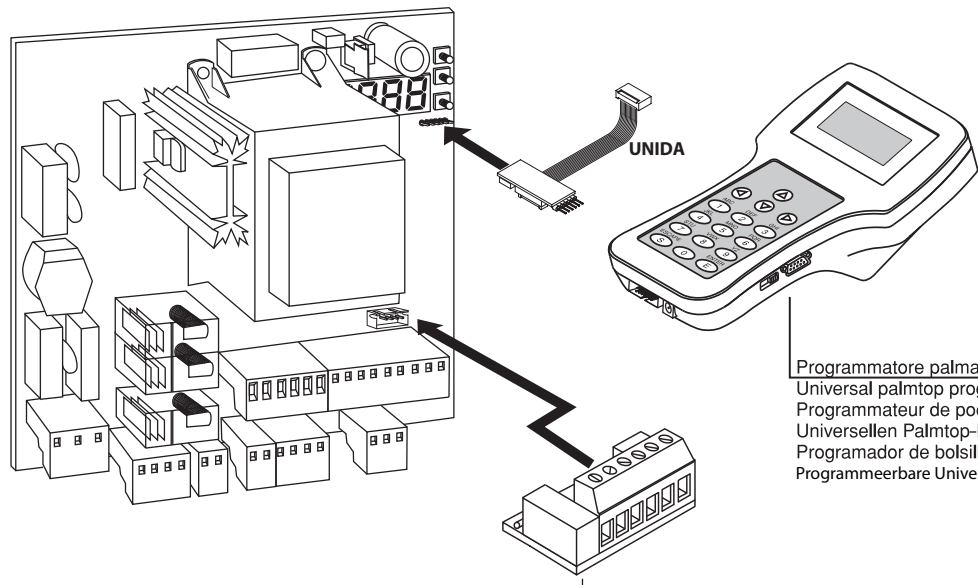

Programmatore palmare universale
 Universal palmtop programmer
 Programmeur de poche universe
 Universellen Palmtop-Programmier
 Programador de bolsillo universal
 Programmeerbare Universele Palmtop



(versione x.40 e successive)
 (x.40 and later versions)
 (version x.40 et suivantes)
 (Version x.40 und nachfolgende)
 (versión x.40 y sucesivas)
 (versie x.40 en hoger)

SCHEDA DI ESPANSIONE
 EXPANSION BOARD
 CARTE D'EXPANSION
 ERWEITERUNGSKARTE
 TARJETA DE EXPANSIÓN
 UITBREIDINGSKAART

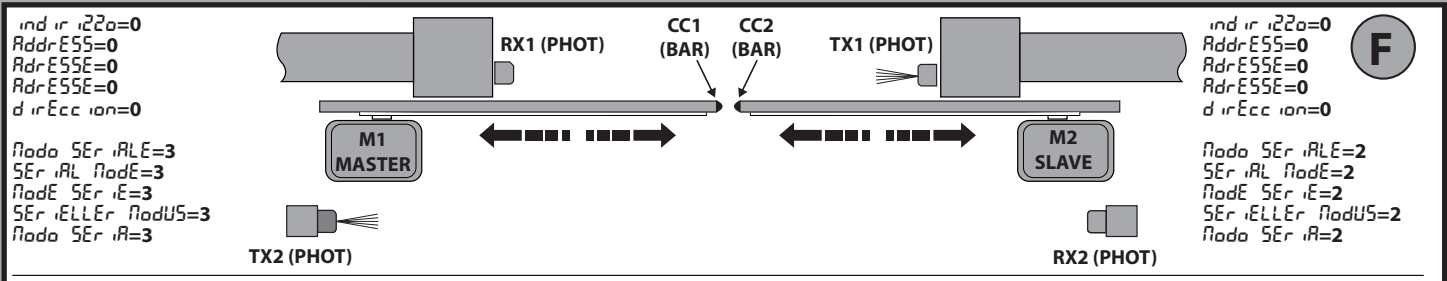

ESEMPIO APPLICAZIONE ANTE CONTRAPPOSTE CON 2 PHOT E 2 BAR - SAMPLE APPLICATION WITH OPPOSITE LEAVES WITH 2 PHOT AND 2 BAR - EXEMPLE D'APPLICATION VANTAUX OPPOSÉS AVEC 2 PHOT ET 2 BAR - ANWENDUNGSBEISPIEL EINANDER ENTGEGENGESETZTE TORFLÜGEL MIT 2 PHOT UND 2 BAR - VOORBEELD TOEPASSING TEGENOVERGESTELDE VLEUGELS MET 2 PHOT EN 2 BAR

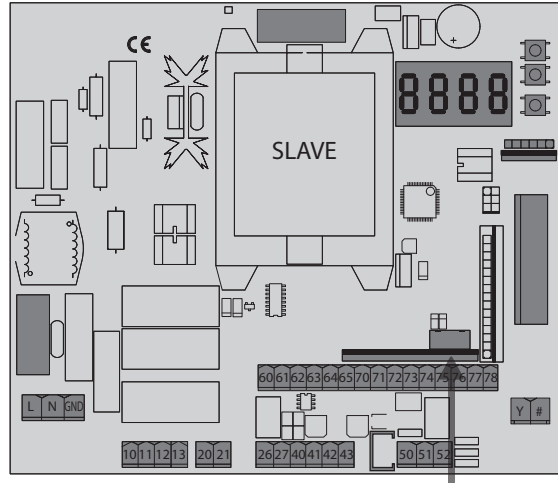
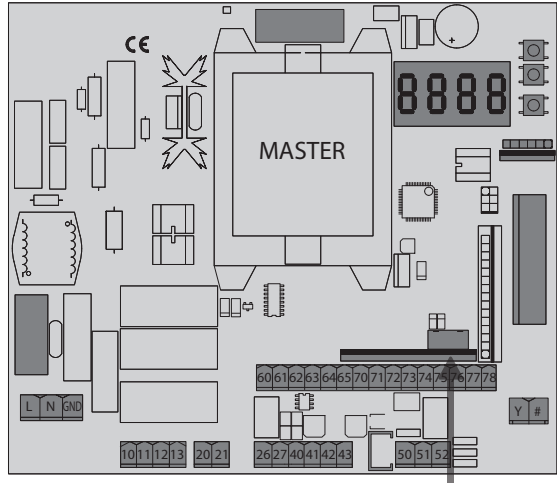

MAX 250m

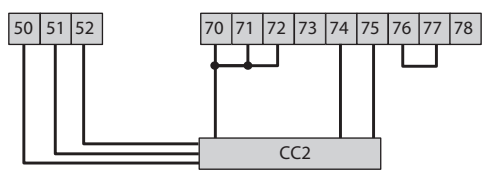
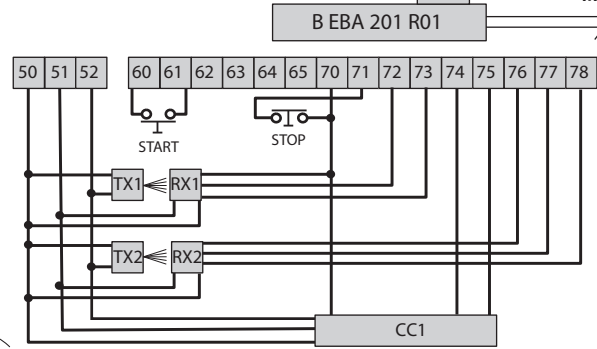

SAFE 1 = 1
 SAFE 2 = 7
 SAFE 3 = 1

SAFE 2 = 7

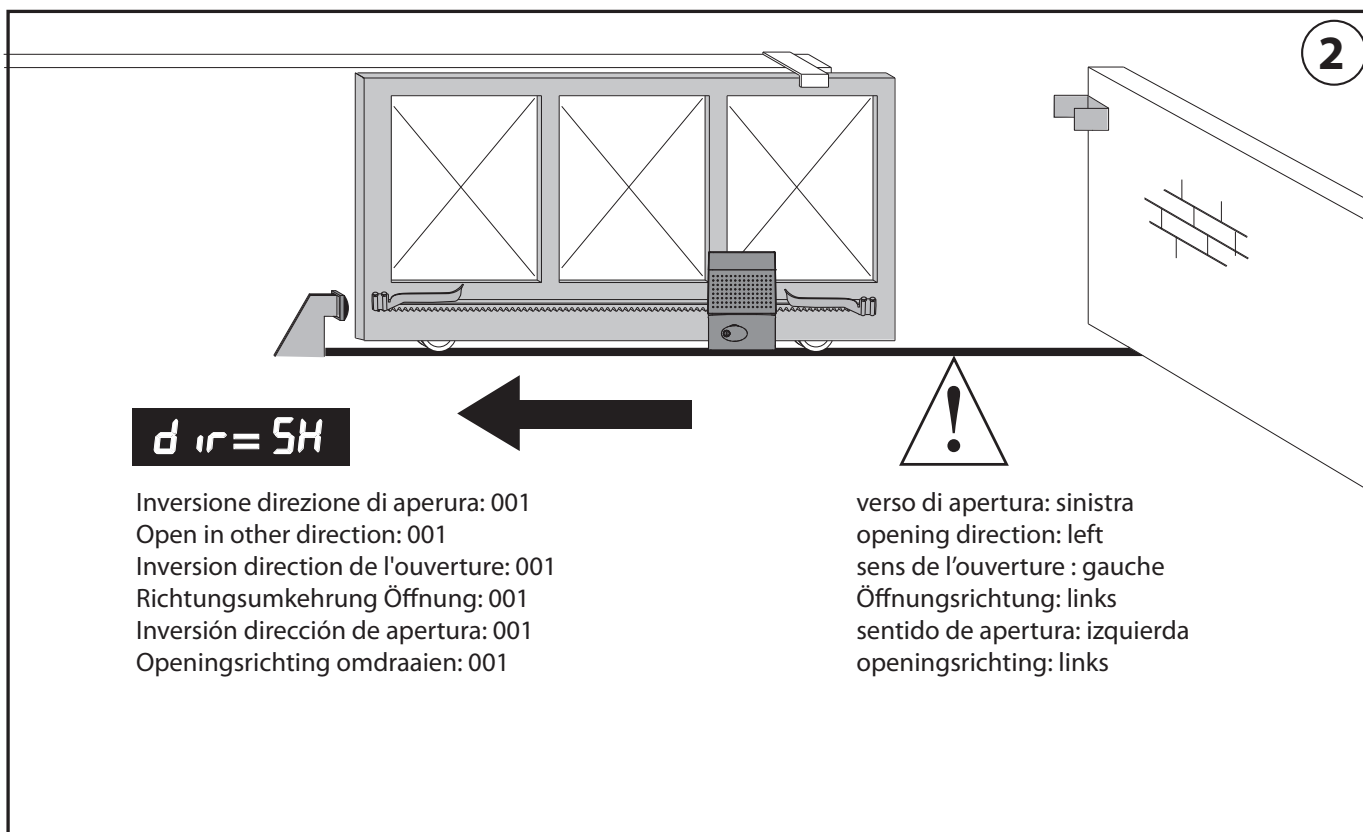
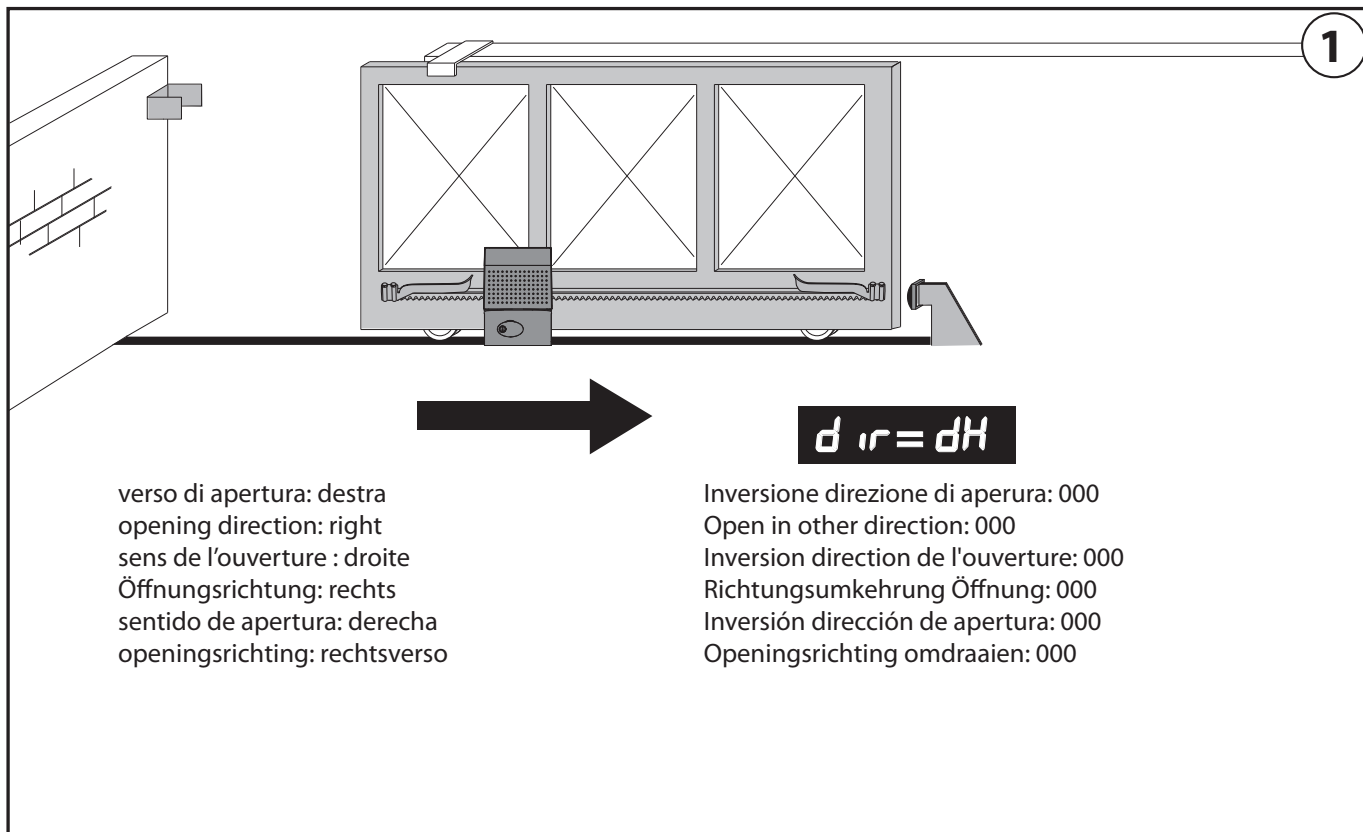

- Nel passaggio di configurazione logica da apertura destra/sinistra, non invertire il collegamento originale dei morsetti 42-43.
- When switching logic configuration from right to left opening, do not swap over original connection of terminals 42-43.
- Lors du passage de configuration logique de l'ouverture droite/gauche, n'inversez pas la connexion d'origine des bornes 42-43
- Bei der Änderung der Logik Öffnung rechts/links nicht den Originalanschluss der Klemmen 42-43 verändern.
- En el paso de configuración lógica de apertura derecha/izquierda no invertir la conexión original de los bornes 42-43.
- Bij de overgang van de logica configuratie van rechts/links openen, de oorspronkelijke aansluiting van de klemmen 42-43 niet omdraaien.

ACCESS MENUS Fig. 1

LEGENDA

+
↑
Scroll up

-
↓
Scroll down

OK
↵
Confirm/Switch on display

+
⊖

-
⊖

Exit Menu

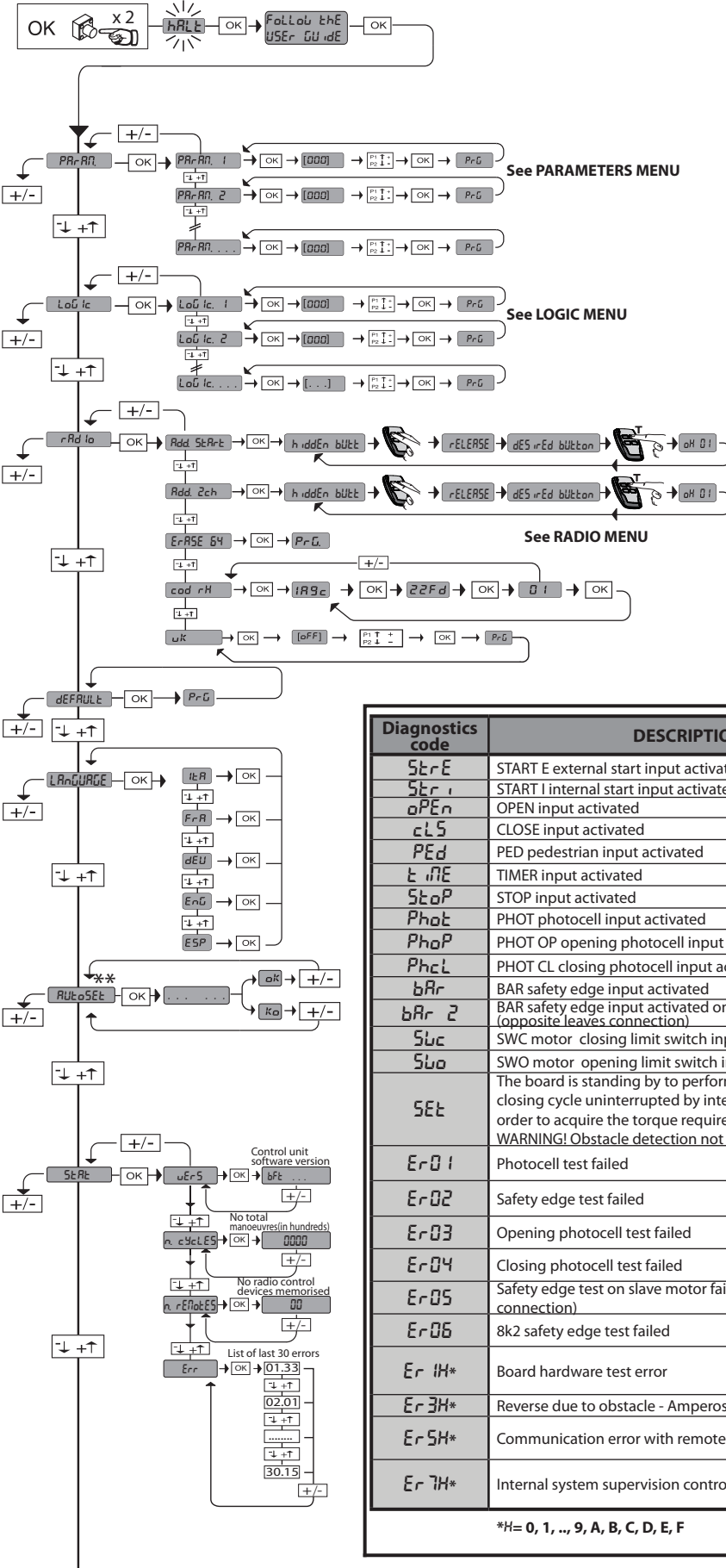

35.40 **

Obstacle threshold

Instantaneous force motor

Diagnostics code	DESCRIPTION	NOTES
StArE	START E external start input activated	
StArI	START I internal start input activated	
oPEn	OPEN input activated	
cLS	CLOSE input activated	
PEd	PED pedestrian input activated	
tIME	TIMER input activated	
StoP	STOP input activated	
Phot	PHOT photocell input activated	
PhoP	PHOT OP opening photocell input activated	
PhcL	PHOT CL closing photocell input activated	
bAr	BAR safety edge input activated	
bAr 2	BAR safety edge input activated on slave motor (opposite leaves connection)	
Sbc	SWC motor closing limit switch input activated	
Sbo	SWO motor opening limit switch input activated	
SEt	The board is standing by to perform a complete opening-closing cycle uninterrupted by intermediate stops in order to acquire the torque required for movement. WARNING! Obstacle detection not active	
Er01	Photocell test failed	Check photocell connection and/or logic settings
Er02	Safety edge test failed	Check safety edge connection and/or logic settings
Er03	Opening photocell test failed	Check photocell connection and/or parameter/logic setting
Er04	Closing photocell test failed	Check photocell connection and/or parameter/logic setting
Er05	Safety edge test on slave motor failed (opposite leaves connection)	Check safety edge connection and/or parameter/logic settings
Er06	8k2 safety edge test failed	Check safety edge connection and/or parameter/logic settings
Er1H*	Board hardware test error	- Check connections to motor - Hardware problems with board (contact technical assistance)
Er3H*	Reverse due to obstacle - Amperstop	Check for obstacles in path
Er5H*	Communication error with remote devices	Check connection with serial-connected accessory devices and/or expansion boards
Er7H*	Internal system supervision control error.	Try switching the board off and back on again. If the problem persists, contact the technical assistance department.

*H= 0, 1, ..., 9, A, B, C, D, E, F

** Only active on LEO B CBB 3 230 L02

INSTALLER WARNINGS

D811893 00100_02

WARNING! Important safety instructions. Carefully read and comply with all the warnings and instructions that come with the product as incorrect installation can cause injury to people and animals and damage to property. The warnings and instructions give important information regarding safety, installation, use and maintenance. Keep hold of instructions so that you can attach them to the technical file and keep them handy for future reference.

GENERAL SAFETY

This product has been designed and built solely for the purpose indicated herein. Uses other than those indicated herein might cause damage to the product and create a hazard.

- The units making up the machine and its installation must meet the requirements of the following European Directives, where applicable: 2004/108/EC, 2006/95/EC, 2006/42/EC, 89/106/EC, 99/05/EC and later amendments. For all countries outside the EEC, it is advisable to comply with the standards mentioned, in addition to any national standards in force, to achieve a good level of safety.
- The Manufacturer of this product (hereinafter referred to as the "Firm") disclaims all responsibility resulting from improper use or any use other than that for which the product has been designed, as indicated herein, as well as for failure to apply Good Practice in the construction of entry systems (doors, gates, etc.) and for deformation that could occur during use.
- Installation must be carried out by qualified personnel (professional installer, according to EN 12635), in compliance with Good Practice and current code.
- Before installing the product, make all structural changes required to produce safety gaps and to provide protection from or isolate all crushing, shearing and dragging hazard areas and danger zones in general in accordance with the provisions of standards EN 12604 and 12453 or any local installation standards. Check that the existing structure meets the necessary strength and stability requirements.
- Before commencing installation, check the product for damage.
- The Firm is not responsible for failure to apply Good Practice in the construction and maintenance of the doors, gates, etc. to be motorized, or for deformation that might occur during use.
- Make sure the stated temperature range is compatible with the site in which the automated system is due to be installed.
- Do not install this product in an explosive atmosphere: the presence of flammable fumes or gas constitutes a serious safety hazard.
- Disconnect the electricity supply before performing any work on the system. Also disconnect buffer batteries, if any are connected.
- Before connecting the power supply, make sure the product's ratings match the mains ratings and that a suitable residual current circuit breaker and overcurrent protection device have been installed upline from the electrical system. Have the automated system's mains power supply fitted with a switch or omnipolar thermal-magnetic circuit breaker with a contact separation that meets code requirements.
- Make sure that upline from the mains power supply there is a residual current circuit breaker that trips at no more than 0.03A as well as any other equipment required by code.
- Make sure the earth system has been installed correctly: earth all the metal parts belonging to the entry system (doors, gates, etc.) and all parts of the system featuring an earth terminal.
- Installation must be carried out using safety devices and controls that meet standards EN 12978 and EN 12453.
- Impact forces can be reduced by using deformable edges.
- In the event impact forces exceed the values laid down by the relevant standards, apply electro-sensitive or pressure-sensitive devices.
- Apply all safety devices (photocells, safety edges, etc.) required to keep the area free of impact, crushing, dragging and shearing hazards. Bear in mind the standards and directives in force, Good Practice criteria, intended use, the installation environment, the operating logic of the system and forces generated by the automated system.
- Apply all signs required by current code to identify hazardous areas (residual risks). All installations must be visibly identified in compliance with the provisions of standard EN 13241-1.
- Once installation is complete, apply a nameplate featuring the door/gate's data.
- This product cannot be installed on leaves incorporating doors (unless the motor can be activated only when the door is closed).
- If the automated system is installed at a height of less than 2.5 m or is accessible, the electrical and mechanical parts must be suitably protected.
- Install any fixed controls in a position where they will not cause a hazard, away from moving parts. More specifically, hold-to-run controls must be positioned within direct sight of the part being controlled and, unless they are key operated, must be installed at a height of at least 1.5 m and in a place where they cannot be reached by the public.
- Apply at least one warning light (flashing light) in a visible position, and also attach a Warning sign to the structure.
- Attach a label near the operating device, in a permanent fashion, with information on how to operate the automated system's manual release.
- Make sure that, during operation, mechanical risks are avoided or relevant protective measures taken and, more specifically, that nothing can be banged, crushed, caught or cut between the part being operated and surrounding parts.
- Once installation is complete, make sure the motor automation settings are correct and that the safety and release systems are working properly.
- Only use original spare parts for any maintenance or repair work. The Firm disclaims all responsibility for the correct operation and safety of the automated system if parts from other manufacturers are used.
- Do not make any modifications to the automated system's components unless explicitly authorized by the Firm.
- Instruct the system's user on what residual risks may be encountered, on the control systems that have been applied and on how to open the system manually in an emergency. Give the user guide to the end user.
- Dispose of packaging materials (plastic, cardboard, polystyrene, etc.) in accordance with the provisions of the laws in force. Keep nylon bags and polystyrene out of reach of children.

WIRING

WARNING! For connection to the mains power supply, use: a multicore cable with a cross-sectional area of at least 5x1.5mm² or 4x1.5mm² when dealing with three-phase power supplies or 3x1.5mm² for single-phase supplies (by way of example, type H05 VV-F cable can be used with a cross-sectional area of 4x1.5mm²). To connect auxiliary equipment, use wires with a cross-sectional area of at least 0.5 mm².

- Only use pushbuttons with a capacity of 10A-250V or more.
- Wires must be secured with additional fastening near the terminals (for example, using cable clamps) in order to keep live parts well separated from safety extra low voltage parts.
- During installation, the power cable must be stripped to allow the earth wire to be connected to the relevant terminal, while leaving the live wires as short as possible. The earth wire must be the last to be pulled taut in the event the cable's fastening device comes loose.

WARNING! safety extra low voltage wires must be kept physically separate from low voltage wires.

Only qualified personnel (professional installer) should be allowed to access live parts.

CHECKING THE AUTOMATED SYSTEM AND MAINTENANCE

Before the automated system is finally put into operation, and during maintenance work, perform the following checks meticulously:

- Make sure all components are fastened securely.
- Check starting and stopping operations in the case of manual control.
- Check the logic for normal or personalized operation.
- For sliding gates only: check that the rack and pinion mesh correctly with 2 mm of play along the full length of the rack; keep the track the gate slides on clean and free of debris at all times.
- For sliding gates and doors only: make sure the gate's running track is straight and horizontal and that the wheels are strong enough to take the weight of the gate.
- For cantilever sliding gates only: make sure there is no dipping or swinging during operation.
- For swing gates only: make sure the leaves' axis of rotation is perfectly vertical.
- For barriers only: before opening the door, the spring must be decompressed (vertical boom).
- Check that all safety devices (photocells, safety edges, etc.) are working properly and that the anti-crush safety device is set correctly, making sure that the force of impact measured at the points provided for by standard EN 12445 is lower than the value laid down by standard EN 12453.
- Impact forces can be reduced by using deformable edges.
- Make sure that the emergency operation works, where this feature is provided.
- Check opening and closing operations with the control devices applied.
- Check that electrical connections and cabling are intact, making extra sure that insulating sheaths and cable glands are undamaged.
- While performing maintenance, clean the photocells' optics.
- When the automated system is out of service for any length of time, activate the emergency release (see "EMERGENCY OPERATION" section) so that the operated part is made idle, thus allowing the gate to be opened and closed manually.
- If the power cord is damaged, it must be replaced by the manufacturer or their technical assistance department or other such qualified person to avoid any risk.
- If "D" type devices are installed (as defined by EN12453), connect in unverified mode, foresee mandatory maintenance at least every six months

WARNING!

Remember that the drive is designed to make the gate/door easier to use and will not solve problems as a result of defective or poorly performed installation or lack of maintenance

SCRAPPING

Materials must be disposed of in accordance with the regulations in force. There are no particular hazards or risks involved in scrapping the automated system. For the purpose of recycling, it is best to separate dismantled parts into like materials (electrical parts - copper - aluminium - plastic - etc.).

DISMANTLING

If the automated system is being dismantled in order to be reassembled at another site, you are required to:

- Cut off the power and disconnect the whole electrical system.
- Remove the actuator from the base it is mounted on.
- Remove all the installation's components.
- See to the replacement of any components that cannot be removed or happen to be damaged.

THE DECLARATION OF CONFORMITY CAN BE VIEWED ON THIS WEBSITE: WWW.BFT.IT IN THE PRODUCT SECTION.

Anything that is not explicitly provided for in the installation manual is not allowed. The operator's proper operation can only be guaranteed if the information given is complied with. The Firm shall not be answerable for damage caused by failure to comply with the instructions featured herein. While we will not alter the product's essential features, the Firm reserves the right, at any time, to make those changes deemed opportune to improve the product from a technical, design or commercial point of view, and will not be required to update this publication accordingly.

INSTALLATION MANUAL

2) GENERAL INFORMATION

The **LEO B CBB 3 230 L02 - LEO B CBB 3 230 L04 - LEO B CBB 3 120 F02 - LEO B CBB 3 120 F04** control panel comes with standard factory settings. Any change must be made using the programmer with built-in display or universal handheld programmer. The Control unit completely supports the EELINK protocol.

Its main features are:

- Control of 1 single-phase motor
- Electronic torque control
- Obstacle detection (only on LEO B CBB 3 230 L02 e LEO B CBB 3 120 F02)
- Separate inputs for safety devices
- Configurable command inputs
- Built-in radio receiver rolling code with transmitter cloning.

The board has a terminal strip of the removable kind to make maintenance or replacement easier. It comes with a series of prewired jumpers to make the installer's job on site easier.

The jumpers concern terminals: 70-71, 70-72, 70-74, 76-77. If the above-mentioned terminals are being used, remove the relevant jumpers.

	LEO B CBB 3 230 L02	LEO B CBB 3 120 F02	LEO B CBB 3 230 L04	LEO B CBB 3 120 F04
Power supply	230V~ ±10% 50Hz/60Hz	120V~ ±10% 50Hz/60Hz	230V~ ±10% 50Hz/60Hz	120V~ ±10% 50Hz/60Hz
Obstacle detection with encoder	Present	Present	Not present	Not present
Output for terminals 26-27: N.O. contact (24V~/0,5A)	AUX3 configurable	Output for audible signal	AUX3 configurable	AUX3 configurable

TESTING

The **LEO B CBB 3 230 L02 - LEO B CBB 3 230 L04 - LEO B CBB 3 120 F02 - LEO B CBB 3 120 F04** panel controls (checks) the start relays and safety devices (photocells) before performing each opening and closing cycle.

If there is a malfunction, make sure that the connected devices are working properly and check the wiring.

WIRING AND TERMINAL BOARD CONFIGURATION

	Terminal	Definition	Description
Power supply	L	LINE	Single-phase power supply 230V~ ±10%, 50-60Hz, with earth cable (LEO B CBB 3 230 L02, LEO B CBB 3 230 L04).
	N	NEUTRAL	
	GND	EARTH	Single-phase power supply 120V~ ±10%, 50-60Hz, with earth cable (LEO B CBB 3 120 F02, LEO B CBB 3 120 F04).
Motor	10	START + CAP	Motor connection. START + CAP Motor Start and capacitor COM Motor Common START MOTOR START CAP capacitor
	11	COM	
	12	START	
	13	CAP	
Aux	20	LIGHT 230V	Flashing light 230V output max. 40W (LEO B CBB 3 230 L02, LEO B CBB 3 230 L04).
	21		Flashing light 120V output max. 40W (LEO B CBB 3 120 F02, LEO B CBB 3 120 F04).
	26	FREE CONTACT (N.O.) (Max 24V 0,5A)	Contact N.O. (24V~/1A).
	27		"AUX3" (LEO B CBB 3 230 L02, LEO B CBB 3 230 L04, LEO B CBB 3 120 F04) FIG. B1 Output for acoustic signal (LEO B CBB 3 120 F02) FIG. B2
Motor 1 limit switch	41	+ REF SWE	Limit switch common
	42	SWC	Closing limit switch SWC (N.C.)
	43	SWO	- Opening limit switch SWO (N.C.)
Accessories power supply	50	24V-	Accessories power supply output.
	51	24V+	
	52	24 Vsafe+	Tested safety device power supply output (photocell transmitter and safety edge transmitter). Output active only during operating cycle.
Commands	60	Common	IC 1 and IC 2 inputs common
	61	IC 1	Configurable command input 1 (N.O.) - Default START E. START E / START I / OPEN / CLOSE / PED / TIMER / TIMER PED Refer to the "Command input configuration" table.
	62	IC 2	Configurable command input 2 (N.O.) - Default PED. START E / START I / OPEN / CLOSE / PED / TIMER / TIMER PED Refer to the "Command input configuration" table.
	63	Common	IC 3 and IC 4 inputs common
	64	IC 3	Configurable command input 3 (N.O.) - Default OPEN. START E / START I / OPEN / CLOSE / PED / TIMER / TIMER PED Refer to the "Command input configuration" table.
	65	IC 4	Configurable command input 4 (N.O.) - Default CLOSE. START E / START I / OPEN / CLOSE / PED / TIMER / TIMER PED Refer to the "Command input configuration" table.

3) TECHNICAL SPECIFICATIONS

Power supply	230V~ ±10% 50Hz/60Hz (LEO B CBB 3 230 L02, LEO B CBB 3 230 L04)
	120V~ ±10% 50Hz/60Hz (LEO B CBB 3 120 F02, LEO B CBB 3 120 F04)
Low voltage/mains insulation	> 2M0hm 500V 
Operating temperature range	-20 / +55°C
Thermal overload protection	Built into motor
Dielectric rigidity	mains/LV 3750V~ for 1 minute
Maximum motor power	750W
Accessories power supply	24V~ (demand max. 1A) 24V~safe
AUX 3/ Output for audible signal	NO contact (24V~/max.0,5A)
Flashing light	230V~ 40W max
Dimensions	146x170x60mm
Fuses	see Fig. B
N° of combinations	4 billion
Max.n° of transmitters that can be memorized	63

Usable transmitter versions:

All ROLLING CODE transmitters compatible with ((€R-Ready))

4) TUBE ARRANGEMENT Fig. A

5) TERMINAL BOARD WIRING Fig. B

WARNINGS - When performing wiring and installation, refer to the standards in force and, whatever the case, apply good practice principles.

Wires carrying different voltages must be kept physically separate from each other, or they must be suitably insulated with at least 1mm of additional insulation. Wires must be secured with additional fastening near the terminals, using devices such as cable clamps.

All connecting cables must be kept far enough away from the dissipater.

INSTALLATION MANUAL

D811893 00100_02

WIRING AND TERMINAL BOARD CONFIGURATION

	Terminal	Definition	Description
Safety devices	70	Common	STOP, SAFE 1 and SAFE 2 inputs common
	71	STOP	The command stops movement. (N.C.) If not used, leave jumper inserted.
	72	SAFE 1	Configurable safety input 1 (N.C.) - Default PHOT. PHOT / PHOT TEST / PHOT OP / PHOT OP TEST / PHOT CL / PHOT CL TEST / BAR / BAR TEST / BAR 8K2 Refer to the "Safety input configuration" table.
	73	FAULT 1	Test input for safety devices connected to SAFE 1.
	74	SAFE 2	Configurable safety input 2 (N.C.) - Default BAR. PHOT / PHOT TEST / PHOT OP / PHOT OP TEST / PHOT CL / PHOT CL TEST / BAR / BAR TEST / BAR 8K2 Refer to the "Safety input configuration" table.
	75	FAULT 2	Test input for safety devices connected to SAFE 2.
	76	Common	SAFE 3 input common
	77	SAFE 3	Configurable safety input 3 (N.C.) - Default PHOT OP. PHOT / PHOT TEST / PHOT OP / PHOT OP TEST / PHOT CL / PHOT CL TEST / BAR / BAR TEST Refer to the "Safety input configuration" table.
	78	FAULT 3	Test input for safety devices connected to SAFE 3.
Antenna	Y	ANTENNA	Antenna input.
	#	SHIELD	Use an antenna tuned to 433MHz. Use RG58 coax cable to connect the Antenna and Receiver. Metal bodies close to the antenna can interfere with radio reception. If the transmitter's range is limited, move the antenna to a more suitable position.

AUX output configuration (Not active on LEO B CBB 3 120 F02)

Aux logic= 0 - 2ND RADIO CHANNEL output.
Contact stays closed for 1s when 2nd radio channel is activated.

Aux logic= 1 - SCA GATE OPEN LIGHT output.
Contact stays closed during opening and with leaf open, intermittent during closing, open with leaf closed.

Aux logic= 2 - COURTESY LIGHT command output.
Contact stays on for 90 seconds after the last operation.

Aux logic= 3 - ZONE LIGHT command output.
Contact stays closed for the full duration of operation.

Aux logic= 4 - STAIR LIGHT output.
Contact stays closed for 1 second at start of operation.

Aux logic= 5 - GATE OPEN ALARM output.
Contact stays closed if the leaf stays open for double the set TCA time.

Aux logic= 6 - FLASHING LIGHT output.
Contact stays closed while leaves are operating.

Aux logic= 7 - SOLENOID LATCH output.
Contact stays closed for 2 seconds each time gate is opened.

Aux logic= 8 - MAGNETIC LOCK output.
Contact stays closed while gate is closed.

Command input configuration

IC logic= 0 - Input configured as Start E. Operation according to 5LEP-bY-5LEP logic. External start for traffic light control.

IC logic= 1 - Input configured as Start I. Operation according to 5LEP-bY-5LEP logic. Internal start for traffic light control.

IC logic= 2 - Input configured as Open.
The command causes the leaves to open. If the input stays closed, the leaves stay open until the contact is opened. When the contact is open, the automated device closes following the TCA time, where activated.

IC logic= 3 - Input configured as Closed.
The command causes the leaves to close.

IC logic= 4 - Input configured as Ped.
The command causes the leaf to open to the pedestrian (partial) opening position. Operation according to 5LEP-bY-5LEP. logic

IC logic= 5 - Input configured as Timer.
Operation same as open except closing is guaranteed even after a mains power outage.

IC logic= 6 - Input configured as Timer Ped.
The command causes the leaf to open to the pedestrian (partial) opening position. If the input stays closed, the leaf stays open until the contact is opened. If the input stays closed and a Start E, Start I or Open command is activated, a complete opening-closing cycle is performed before returning to the pedestrian opening position. Closing is guaranteed even after a mains power outage.

Safety input configuration

SAFE logic= 0 - Input configured as Phot (photocell) non tested (*) (fig.D, ref.1).
Enables connection of devices not equipped with supplementary test contacts. When beam is broken, photocells are active during both opening and closing. When beam is broken during closing, movement is reversed only once the photocell is cleared. If not used, leave jumper inserted.

SAFE logic= 1 - Input configured as Phot test (tested photocell). (fig.D, ref.2).
Switches photocell testing on at start of operation. When beam is broken, photocells are active during both opening and closing. When beam is broken during closing, movement is reversed only once the photocell is cleared.

SAFE logic= 2 - Input configured as Phot op (photocell active during opening only) non tested (*) (fig.D, ref.1).
Enables connection of devices not equipped with supplementary test contacts. In the event beam is broken, photocell operation is disabled during closing. During opening, stops motion for as long as the photocell beam stays broken. If not used, leave jumper inserted.

SAFE logic= 3 - Input configured as Phot op test (tested photocell active during opening only) (fig.D, ref.2).
Switches photocell testing on at start of operation. In the event beam is broken, photocell operation is disabled during closing. During opening, stops motion for as long as the photocell beam stays broken.

SAFE logic= 4 - Input configured as Phot cl (photocell active during closing only) non tested (*) (fig.D, ref.1).
Enables connection of devices not equipped with supplementary test contacts. In the event beam is broken, photocell operation is disabled during opening. During closing, movement is reversed immediately. If not used, leave jumper inserted.

SAFE logic= 5 - Input configured as Phot cl test (tested photocell active during closing only) (fig.D, ref.2).
Switches photocell testing on at start of operation. In the event beam is broken, photocell operation is disabled during opening. During closing, movement is reversed immediately.

SAFE logic= 6 - Input configured as Bar (safety edge) non tested (*) (fig.D, ref.3).
Enables connection of devices not equipped with supplementary test contacts. The command reverses movement for 2 sec.. If not used, leave jumper inserted.

SAFE logic= 7 - Input configured as Bar (tested safety edge) (fig.D, ref.4).
Switches safety edge testing on at start of operation. The command reverses movement for 2 sec.

SAFE logic= 8 - Input configured as Bar 8k2 (fig.D, ref.5). Input for resistive edge 8K2.
The command reverses movement for 2 sec..

(*) If "D" type devices are installed (as defined by EN12453), connect in unverified mode, foresee mandatory maintenance at least every six months.

6) SAFETY DEVICES

Note: only use receiving safety devices with free changeover contact.

6.1) TESTED DEVICES Fig. D

6.2) CONNECTION OF 1 PAIR OF NON-TESTED PHOTOCELLS FIG. C

7) CALLING UP MENUS: FIG. 1

7.1) PARAMETERS MENU (PRR-RF) (PARAMETERS TABLE "A")

7.2) LOGIC MENU (LÖG IC) (LOGIC TABLE "B")

7.3) RADIO MENU (RAD IO) (RADIO TABLE "C")

IMPORTANT NOTE: THE FIRST TRANSMITTER MEMORIZED MUST BE IDENTIFIED BY ATTACHING THE KEY LABEL (MASTER).

In the event of manual programming, the first transmitter assigns the RECEIVER'S KEY CODE: this code is required to subsequently clone the radio transmitters.

The Clonix built-in on-board receiver also has a number of important advanced features:

- Cloning of master transmitter (rolling code or fixed code).
- Cloning to replace transmitters already entered in receiver.
- Transmitter database management.
- Receiver community management.

To use these advanced features, refer to the universal handheld programmer's instructions and to the general receiver programming guide.

7.4) DEFAULT MENU (DEF RUL T)

Restores the controller's DEFAULT factory settings. Following this reset, you will need to run the AUTOSET function again.

7.5) LANGUAGE MENU (L AN G U A G E)

Used to set the programmer's language on the display.

7.6) AUTOSET MENU (A U T O S E T)

(ONLY ACTIVE ON LEO B CBB 3 230 L02)

- Launch an autosest operation by going to the relevant menu.
- As soon as you press the OK button, the "....." message is displayed and the control unit commands the device to perform a full cycle (opening followed by closing), during which the minimum torque value required to move the leaf is set automatically. The number of cycles required for the autosest function can range from 1 to 3. During this stage, it is important to avoid breaking the photocells' beams and not to use the START and STOP commands or the display.
- Once this operation is complete, the control unit will have automatically set the optimum force values, slow-down distances and operation times. Check them and, where necessary, edit them as described in the programming section.

WARNING!! Check that the force of impact measured at the points provided for by standard EN 12445 is lower than the value laid down

by standard EN 12453.

Impact forces can be reduced by using deformable edges.



Warning!! While the autosest function is running, the obstacle detection function is not active. Consequently, the installer must monitor the automated system's movements and keep people and property out of range of the automated system.



INSTALLATION TEST PROCEDURE

1. Run the AUTOSET cycle (*)
2. Check the impact forces: if they fall within the limits (**) skip to point 10, otherwise
3. Where necessary, adjust the sensitivity (force) parameters: see parameters table.
4. Check the impact forces again: if they fall within the limits (**) skip to point 10, otherwise
5. Apply a shock absorber profile
6. Check the impact forces again: if they fall within the limits (**) skip to point 10, otherwise
7. Apply pressure-sensitive or electro-sensitive protective devices (such as a safety edge (**))
8. Check the impact forces again: if they fall within the limits (**) skip to point 10, otherwise
9. Allow the drive to move only in "Deadman" mode
10. Make sure all devices designed to detect obstacles within the system's operating range are working properly

(*) Before running the autosest function, make sure you have performed all the assembly and make-safe operations correctly, as set out in the installation warnings in the drive's manual.

(**) Based on the risk analysis, you may find it necessary to apply sensitive protective devices anyway

7.7) STATISTICS MENU

Used to view the version of the board, the total number of operations (in hundreds), the number of transmitters memorized and the last 30 errors (the first 2 digits indicate the position, the last 2 give the error code). Error 01 is the most recent.

7.8) PASSWORD MENU

Used to set a password for the board's wireless programming.

8) U-LINK OPTIONAL MODULES

Refer to the U-link instructions for the modules.

9) OPPOSITE SLIDING LEAVES (FIG. F)

Refer to the U-link instructions for the modules.

NOTE: On the board set as the Slave, the Safety Edge input (Safety Edge/Test Safety Edge/ 8k2 Safety Edge) should only be set to SAFE2.

TABLE "A" - PARAMETERS MENU - (PRR-RF)

Parameter	min.	max.	Default	Personal	Definition	Description
oPEn uoRkE	5	300	300		Opening operation time [s]	Maximum motor operation time, during opening. Set the operation time so that it's slightly longer than the complete operating cycle time. The value is changed by the Autosest cycle, adapting it to the operation time detected
cLS uoRkE	5	300	300		Closing operation time [s]	Maximum motor operation time, during closing. Set the operation time so that it's slightly longer than the complete operating cycle time. The value is changed by the Autosest cycle, adapting it to the operation time detected
tCR	0	180	40		Automatic closing time [s]	Waiting time before automatic closing.
tRFLGhEclRt	1	180	40		Time-to-clear traffic light zone [s]	Time-to-clear for the zone run through by traffic controlled by the traffic light.
oPd iStSlouD	0	99	30		Slow-down distance during opening [%]	Slow-down distance for motor(s) during opening, given as a percentage of total travel. The Autosest cycle changes the slow-down distance values if they don't allow at least 50cm of travel at slowed speed. WARNING: Once the parameter has been edited, a complete uninterrupted opening-closing cycle is required. WARNING: when the display reads "SET", obstacle detection is not active.
cLd iStSlouD	0	99	30		Slow-down distance during closing [%]	Slow-down distance for motor(s) during closing, given as a percentage of total travel. The Autosest cycle changes the slow-down distance values if they don't allow at least 50cm of travel at slowed speed. WARNING: Once the parameter has been edited, a complete uninterrupted opening-closing cycle is required. WARNING: when the display reads "SET", obstacle detection is not active.
PRRt iRL oPEn iNG	10	50	20		Partial opening [%]	Partial opening distance as a percentage of total opening following activation of PED pedestrian command.
oPForcE	1	99	41 (LEO B CBB 3 230 L02) 75 (Other models)		Leaf force during opening [%]	Force exerted by leaf/leaves during opening. Only for LEO B CBB 3 230 L02: This is the percentage of force delivered, beyond the force stored during the autosest cycle (and subsequently updated), before an obstacle alarm is generated. The parameter is set automatically by the autosest function. WARNING: It affects impact force directly: make sure that current safety requirements are met with the set value (*). Install anti-crush safety devices where necessary (**).
cLSForcE	1	99	41 (LEO B CBB 3 230 L02) 75 (Other models)		Leaf force during closing [%]	Force exerted by leaf/leaves during closing. Only for LEO B CBB 3 230 L02: This is the percentage of force delivered, beyond the force stored during the autosest cycle (and subsequently updated), before an obstacle alarm is generated. The parameter is set automatically by the autosest function. WARNING: It affects impact force directly: make sure that current safety requirements are met with the set value (*). Install anti-crush safety devices where necessary (**).

(*) In the European Union, apply standard EN 12453 for force limitations, and standard EN 12445 for measuring method.

(**) Impact forces can be reduced by using deformable edges.

INSTALLATION MANUAL

D811893 00100_02

Parameter	min.	max.	Default	Personal	Definition	Description
<i>oP.SLud. Force</i>	1	99	75		Leaf/leaves force during opening during slow-down	<p>"Force exerted by leaf/leaves during opening at slow-down speed." Only for LEO B CBB 3 230 L02: This is the percentage of force delivered, beyond the force stored during the autosect cycle (and subsequently updated), before an obstacle alarm is generated. The parameter is set automatically by the autosect function.</p> <p>WARNING: It affects impact force directly: make sure that current safety requirements are met with the set value (*). Install anti-crush safety devices where necessary (**).</p>
<i>cL.S.SLud. Force</i>	1	99	75		Leaf/leaves force during closing during slow-down [%]	<p>"Force exerted by leaf/leaves during closing at slow-down speed." Only for LEO B CBB 3 230 L02: This is the percentage of force delivered, beyond the force stored during the autosect cycle (and subsequently updated), before an obstacle alarm is generated. The parameter is set automatically by the autosect function.</p> <p>WARNING: It affects impact force directly: make sure that current safety requirements are met with the set value (*). Install anti-crush safety devices where necessary (**).</p>
<i>brAKE</i>	1	99	0		Braking [%]	Percentage of braking applied to stop motion of motor(s).

(*) In the European Union, apply standard EN 12453 for force limitations, and standard EN 12445 for measuring method.



(**) Impact forces can be reduced by using deformable edges.

TABELLA "B" - LOGICHE - (LOGIC)

Logic	Definition	Default	Cross out setting used	Optional extras																									
<i>tCA</i>	Automatic Closing Time	0	0	Logic not enabled																									
			1	Switches automatic closing on																									
<i>FAST cLS.</i>	Fast closing	0	0	Logic not enabled																									
			1	Closes 3 seconds after the photocells are cleared before waiting for the set TCA to elapse.																									
<i>STEP-by-STEP MOVEMENT</i>	Step-by-step movement	0	0	Inputs configured as Start E, Start I, Ped operate with 4-step logic.																									
			1	Inputs configured as Start E, Start I, Ped operate with 3-step logic. Pulse during closing reverses movement.																									
			2	Inputs configured as Start E, Start I, Ped operate with 2-step logic. Movement reverses with each pulse.																									
			<table border="1" style="width: 100%; text-align: center;"> <thead> <tr> <th colspan="4">step-by-step mov.</th> </tr> <tr> <th></th> <th>2 STEP</th> <th>3 STEP</th> <th>4 STEP</th> </tr> </thead> <tbody> <tr> <td>CLOSED</td> <td></td> <td></td> <td>OPENS</td> </tr> <tr> <td>DURING CLOSING</td> <td>OPENS</td> <td>OPENS</td> <td>STOPS</td> </tr> <tr> <td>OPEN</td> <td></td> <td>CLOSES</td> <td>CLOSES</td> </tr> <tr> <td>DURING OPENING</td> <td>CLOSES</td> <td>STOP + TCA</td> <td>STOP + TCA</td> </tr> <tr> <td>AFTER STOP</td> <td>OPENS</td> <td>OPENS</td> <td>OPENS</td> </tr> </tbody> </table>		step-by-step mov.					2 STEP	3 STEP	4 STEP	CLOSED			OPENS	DURING CLOSING	OPENS	OPENS	STOPS	OPEN		CLOSES	CLOSES	DURING OPENING	CLOSES	STOP + TCA	STOP + TCA	AFTER STOP
step-by-step mov.																													
	2 STEP	3 STEP	4 STEP																										
CLOSED			OPENS																										
DURING CLOSING	OPENS	OPENS	STOPS																										
OPEN		CLOSES	CLOSES																										
DURING OPENING	CLOSES	STOP + TCA	STOP + TCA																										
AFTER STOP	OPENS	OPENS	OPENS																										

<i>Encoder</i> (Only active on LEO B CBB 3 230 L02)	Encoder	2	1	Operation with encoder used as position sensor for acquiring slow-down distances. - Gate detection locked out. Manual setting of "opening force", "closing force", "opening slow-down force" and "closing slow-down force" parameters.
			2	Automatic mode with encoder: slow-down and obstacle detection performed by means of encoder. Option of using "autosect" function. Adjustment of obstacle detection sensitivity (opening force, closing force, opening slow-down force, closing slow-down force parameters) (default setting). WARNING: Check that the force of impact measured at the points provided for by standard EN 12445 is lower than the value laid down by standard EN 12453.  WARNING: Setting sensitivity incorrectly can result in damage to property and injury to people and animals.

<i>PRE-ALARm</i>	Pre-alarm	0	0	The flashing light comes on at the same time as the motor(s) start.
			1	The flashing light comes on approx. 3 seconds before the motor(s) start.

<i>hold-to-run</i>	Deadman	0	0	Pulse operation.
			1	Deadman mode. Input 61 is configured as OPEN UP. Input 62 is configured as CLOSE UP. Operation continues as long as the OPEN UP or CLOSE UP keys are held down.  WARNING: safety devices are not enabled.
			2	Emergency Deadman mode. Usually pulse operation. If the board fails the safety device tests (photocell or safety edge, Er0x) 3 times in a row, the device is switched to Deadman mode, which will stay active until the OPEN UP or CLOSE UP keys are released. Input 61 is configured as OPEN UP. Input 62 is configured as CLOSE UP.  WARNING: with the device set to Emergency Deadman mode, safety devices are not enabled.

INSTALLATION MANUAL

Logic	Definition	Default	Cross out setting used	Optional extras
iBL oPEN	Block pulses during opening	0	0	Pulse from inputs configured as Start E, Start I, Ped has effect during opening.
			1	Pulse from inputs configured as Start E, Start I, Ped has no effect during opening.
iBL tCA	Block pulses during TCA	0	0	Pulse from inputs configured as Start E, Start I, Ped has effect during TCA pause.
			1	Pulse from inputs configured as Start E, Start I, Ped has no effect during TCA pause.
iBL cLOSE	Block pulses during closing	0	0	Pulse from inputs configured as Start E, Start I, Ped has effect during closing.
			1	Pulse from inputs configured as Start E, Start I, Ped has no effect during closing.
oPEN in othEr dIrEct.	Open in other direction	0	0	Standard operating mode (Fig.G Rif. 1).
			1	Opens in other direction to standard operating mode (Fig. G Rif.2)
SAFE 1	Configuration of safety input SAFE 1. 72	0	0	Input configured as Phot (photocell).
			1	Input configured as Phot test (tested photocell).
			2	Input configured as Phot op (photocell active during opening only).
SAFE 2	Configuration of safety input SAFE 2. 74	6	3	Input configured as Phot op test (tested photocell active during opening only).
			4	Input configured as Phot cl (photocell active during closing only).
			5	Input configured as Phot cl test (tested photocell active during closing only).
SAFE 3	Configuration of safety input SAFE 3. 77	2	6	Input configured as Bar, safety edge.
			7	Input configured as Bar, tested safety edge.
			8	Input configured as Bar 8k2 (Not active on SAFE 3).
iC 1	Configuration of command input IC 1. 61	0	0	Input configured as Start E.
			1	Input configured as Start I.
iC 2	Configuration of command input IC 2. 62	4	2	Input configured as Open.
			3	Input configured as Close.
iC 3	Configuration of command input IC 3. 64	2	4	Input configured as Ped.
			5	Input configured as Timer.
iC 4	Configuration of command input IC 4. 65	3	6	Input configured as Timer Pedestrian.
AUX 3 (Setup for LEO B CBB 3 120 F02)	Configuration of AUX 3 output. 26-37	0	0	Output configured as 2nd Radio Channel.
			1	Output configured as SCA (gate open light).
			2	Output configured as Courtesy Light command.
			3	Output configured as Zone Light command.
			4	Output configured as Stair Light
			5	Output configured as Alarm
			6	Output configured as Flashing light
F ixEd code	Fixed code	0	0	Receiver is configured for operation in rolling-code mode. Fixed-Code Clones are not accepted.
			1	Receiver is configured for operation in fixed-code mode. Fixed-Code Clones are accepted.
rAd io ProG	Transmitter programming	1	0	Disables wireless memorizing of transmitters. Transmitters are memorized only using the relevant Radio menu. IMPORTANT: This high level of security stops unwanted clones from gaining access and also stops radio interference, if any
			1	A- Enables wireless memorizing of transmitters: Operations in this mode are carried out near the control panel and do not require access: - Press in sequence the hidden key and normal key (T1-T2-T3-T4) of a transmitter that has already been memorized in standard mode via the radio menu. - Press within 10 sec. the hidden key and normal key (T1-T2-T3-T4) of a transmitter to be memorized. The receiver exits programming mode after 10 sec.: you can use this time to enter other new transmitters by repeating the previous step B-Enables wireless automatic addition of clones and replays. Enables clones generated with the universal programmer and programmed replays to be added to the receiver's memory.

INSTALLATION MANUAL

D811893 00100_02

Logic	Definition	Default	Cross out setting used	Optional extras
<i>SERIAL MODE</i>	Serial mode (Identifies how board is configured in a BFT network connection).	0	0	Standard SLAVE: board receives and communicates commands/diagnostics/etc.
			1	Standard MASTER: board sends activation commands (START, OPEN, CLOSE, PED, STOP) to other boards.
			2	SLAVE opposite leaves in local network : the control unit is the slave in an opposite leaves network with no smart module (fig.F)
			3	MASTER opposite leaves in local network: the control unit is the master in an opposite leaves network with no smart module (fig.F)
<i>ADDRESS</i>	Address	0	[____]	Identifies board address from 0 to 127 in a local BFT network connection. (see U-LINK OPTIONAL MODULES section)
<i>EXP 1</i>	Configuration of EXPI1 input on input-output expansion board. 1-2	1	0	Input configured as Start E command.
			1	Input configured as Start I command.
			2	Input configured as Open command.
			3	Input configured as Close command.
			4	Input configured as Ped command.
			5	Input configured as Timer command.
			6	Input configured as Timer Pedestrian command.
			7	Input configured as Phot (photocell) safety.
			8	Input configured as Phot op safety (photocell active during opening only).
			9	Input configured as Phot cl safety (photocell active during closing only).
			10	Input configured as Bar safety (safety edge).
			11	Input configured as Phot test safety (tested photocell). Input 3 (EXPI2) on input/output expansion board is switched automatically to safety device test input, EXPFAULT1.
			12	Input configured as Phot op test safety (tested photocell active during opening only). Input 3 (EXPI2) on input/output expansion board is switched automatically to safety device test input, EXPFAULT1.
			13	Input configured as Phot cl test safety (tested photocell active during closing only). Input 3 (EXPI2) on input/output expansion board is switched automatically to safety device test input, EXPFAULT1.
14	Input configured as Bar safety (tested safety edge). Input 3 (EXPI2) on input/output expansion board is switched automatically to safety device test input, EXPFAULT1.			
<i>EXP 2</i>	Configuration of EXPI2 input on input-output expansion board. 1-3	0	0	Input configured as Start E command.
			1	Input configured as Start I command.
			2	Input configured as Open command.
			3	Input configured as Close command.
			4	Input configured as Ped command.
			5	Input configured as Timer command.
			6	Input configured as Timer Pedestrian command.
			7	Input configured as Phot (photocell) safety.
			8	Input configured as Phot op safety (photocell active during opening only).
			9	Input configured as Phot cl safety (photocell active during closing only).
			10	Input configured as Bar safety (safety edge).

INSTALLATION MANUAL

Logic	Definition	Default	Cross out setting used	Optional extras
EHPo1	Configuration of EXPO2 output on input-output expansion board 4-5	9	0	Output configured as 2 nd Radio Channel.
			1	Output configured as SCA (gate open light).
			2	Output configured as Courtesy Light command.
			3	Output configured as Zone Light command.
			4	Output configured as Stair Light.
EHPo2	Configuration of EXPO2 output on input-output expansion board 6-7	9	5	Output configured as Alarm.
			6	Output configured as Flashing light.
			7	Output configured as Latch.
			8	Output configured as Magnetic lock.
			9	Output configured as Traffic Light control with TLB board.
ErAFF ic L iGht PrEFLASH inG	Traffic light pre-flashing	0	0	Pre-flashing switched off.
			1	Red lights flash, for 3 seconds, at start of operation.
ErAFF ic L iGht rEd LAMP ALLAYS on	Steadily lit red light	0	0	Red lights off when gate closed.
			1	Red lights on when gate closed.

TABLE "C" – RADIO MENU (rAd io)

Logic	Description
Add StArt	Add Start Key associates the desired key with the Start command
Add 2ch	Add 2ch Key associates the desired key with the 2nd radio channel command. Associates the desired key with the 2nd radio channel command. If no output is configured as 2nd Radio Channel Output, the 2nd radio channel controls the pedestrian opening.
ErASE bY	Erase List  WARNING! Erases all memorized transmitters from the receiver's memory.
cod rH	Read receiver code Displays receiver code required for cloning transmitters.
uK	ON = Enables remote programming of cards via a previously memorized W LINK transmitter. It remains enabled for 3 minutes from the time the W LINK transmitter is last pressed. OFF = W LINK programming disabled.

Bft Spa

Via Lago di Vico, 44
36015 Schio (VI)
T +39 0445 69 65 11
F +39 0445 69 65 22
→ www.bft.it

**SPAIN**

BFT GROUP ITALIBERICA DE AUTOMATISMOS S.L.
08401 Granollers - (Barcelona)
www.bftautomatismos.com

FRANCE

AUTOMATISMES BFT FRANCE
69800 Saint Priest
www.bft-france.com

GERMANY

BFT TORANTRIEBSSYSTEME GmbH
90522 Oberasbach
www.bft-torantriebe.de

UNITED KINGDOM

BFT AUTOMATION UK LTD
Stockport, Cheshire, SK7 5DA
www.bft.co.uk

IRELAND

BFT AUTOMATION LTD
Dublin 12

BENELUX

BFT BENELUX SA
1400 Nivelles
www.bftbenelux.be

POLAND

BFT POLSKA SP. Z O.O.
05-091 ZĄBKI
www.bft.pl

CROATIA

BFT ADRIA D.O.O.
51218 Drazice (Rijeka)
www.bft.hr

PORTUGAL

BFT SA-COMERCIO DE AUTOMATISMOS E MATERIAL DE SEGURANCIA
3020-305 Coimbra
www.bftportugal.com

CZECH REPUBLIC

BFT CZ S.R.O.
Praha
www.bft.it

TURKEY

BFT OTOMATIK KAPI SISTEMELERİ SANAY VE
İstanbul
www.bftotomasyon.com.tr

RUSSIA

BFT RUSSIA
111020 Moscow
www.bftrus.ru

AUSTRALIA

BFT AUTOMATION AUSTRALIA PTY LTD
Wetherill Park (Sydney)
www.bftaustralia.com.au

U.S.A.

BFT USA
Boca Raton
www.bft-usa.com

CHINA

BFT CHINA
Shanghai 200072
www.bft-china.cn

UAE

BFT Middle East FZCO
Dubai