

DS-7000HI-S Series Net DVR User Manual

V2.1

Thank you for purchasing our Net DVR. This manual is applicable to DS-7000HI-S series Net DVR. Please read this User Manual carefully to ensure that you can use the device correctly and safely.

The contents of this Manual are subject to change without notice.

Index

Chapter1	Product Introduction.....	4
1.1	Summary	4
1.2	Model Description.....	4
1.3	Features	4
Chapter2	Installation.....	7
2.1	Checking the DVR and Its Accessories.....	7
2.2	HDD Installation	7
2.3	Rear Panel Description.....	8
2.4	External Alarm In/Out Connection	8
Chapter3	Operational Instructions	10
3.1	Front Panel	10
3.2	IR Remote control.....	12
3.3	Menu Description.....	14
3.3.1	Menu Items	14
3.3.2	Menu Operation	15
3.4	Character Input.....	17
Chapter4	Basic Operation Guide	18
4.1	Power on	18
4.2	Preview.....	18
4.2.1	Main Preview	18
4.2.2	Spot Preview	21
4.3	User name and password.....	22
4.4	PTZ Control	24
4.5	Manual Record.....	26
4.6	Playback	27
4.7	Backup Recorded Files	31
4.8	Shut down DVR	34
Chapter5	Parameters Setup Guide	37
5.1	Administrator and Password	37
5.2	Add and Delete User	39
5.3	Unit Name and Device ID.....	43
5.4	Video Output Standard and VGA Setup.....	44
5.5	OSD Setup.....	44
5.6	Video Parameters Setup	48
5.7	Mask Area Setup	49
5.8	View Tampering Alarm	51
5.9	Video Loss Alarm.....	53
5.10	Motion Detection Alarm	55
5.11	Preview Properties	59
5.12	Recording Setup.....	61
5.13	External Alarm Input and Relay Output.....	66
5.14	Network Parameters	70

5.15	PTZ	73
5.16	RS232 setup	78
5.17	Exceptions.....	84
5.18	Transaction Information.....	85
Chapter6	Utilities.....	89
6.1	Save Parameters	89
6.2	Restore Parameters.....	89
6.3	Upgrade.....	90
6.4	Hard Disk Management	91
6.5	Clear Alarm Out	91
6.6	Reboot	92
6.7	Power Off.....	92
6.8	View Log.....	92
6.9	System Information.....	95
Chapter7	Firmware Upgrade	96
7.1	FTP Server Setup	96
7.2	Upgrade Mode.....	99
Appendix A	Mouse Control Function	103
Appendix B	HDD Capacity Calculation	105
Appendix C	DVR Connect Cable Definition	106
Appendix D	Specifications	108
Appendix E	List of Recommended DVR Peripherals.....	110
Appendix F	Quick Search Function Table	115
Appendix G	Troubleshooting	117
Appendix H	Product Service	119
Appendix I	Customer Information Card	120

Chapter1 Product Introduction

1.1 Summary

DS-7000HI-S series network digital video recorder is an excellent digital surveillance product applies the embedded MCU and real time operating system, along with the most advanced technology in the Information Technology Industry such as video and audio encoding/decoding, hard disk record and TCP/IP. The firmware is burned into the flash, making the product more stable and reliable.

DS-7000HI-S series device has advantages of digital video recorder (DVR) and digital video server (DVS). It can work standalone, also be applied to build up a powerful surveillance network. DS-7000HI-S series device can be widely used in bank, telecommunication, transportation, factories, warehouse, irrigation, etc.

1.2 Model Description

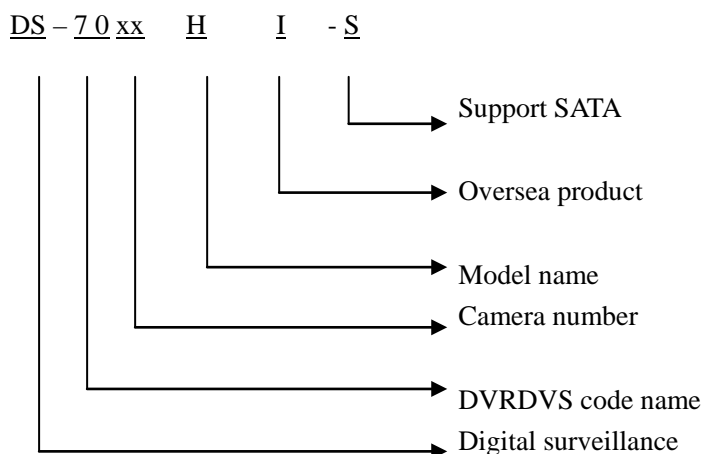

1.3 Features

Compression

- Support max 16 channels video input (PAL/NTSC) at most. Each channel is independent with H.264 hardware compression.
- Support both variable bit rate and frame rate.
- Support max 4 channels audio input. Each channel is independent with OggVorbis compression at a bit rate of 16Kbps.
- Compressed video and audio are synchronous. Either composited stream or video-only stream can be selected. For DS-7016HI-S, first 4 channels support both composited

stream and video-only stream, the rest channels merely support video-only stream.

- Support video loop out.
- Support up to 4CIF (DS-7004HI-S), 2CIF (DS-7008HI-S & DS-7016HI-S) resolution.

Local Functions

Recording

- Support multiple recording types, including schedule recording, manual recording, alarm recording, motion detection recording, motion&alarm recording, motion|alarm recording.
- Support NAS Recording.
- Support Event Recording Para. Setup.
- Support max 4 SATA HDDs and each HDD can max support 2000GB.
- Support FAT32 file system
- Support HDD S.M.A.R.T technology.
- Support cycle or none cycle recording.
- Support backup the recorded files and clips with USB DISK, USB HDD, USB CD-R/W, USB DVD-R/W, SATA CD-R/W or SATA DVD-R/W

Preview & Playback

- Support BNC analog monitor and VGA output.
- Support multiple preview modes.
- Support privacy mask
- Support view tampering alert.
- Support playback by files or by time.
- Support video signal loss alert.
- Support play forward, backward, pause, frame-by-frame, etc
- User-defined preview layout.
- Display local recording status.

PTZ

- Support various PTZ protocols.
- Support preset, sequence and cruise.

Alarms

- Support exception alarm, motion detection alarm, external alarm, etc.

Others

- Support IR remote control.
- Support multi-level user management.
- Support Mouse Operation Menu.
- Support multi-area motion detection.
- Support OSD and changeable OSD position.

- Support multiple upgrade modes, including FTP, USB and CD.

Network

- Support Advanced Network Function: NTP, DDNS and E-mail.
- Support TCP, UDP, RTP, and Multicast for network preview.
- Support PPPoE
- Support remote parameters setup.
- Alarm information can be sent to remote center.
- Network control PTZ.
- Network record live stream.
- Network download and playback the recorded files in DVR.
- Remote upgrade the firmware.
- RS-232 supports transparent channel function so that the remote PC can control serial devices through DVR.
- Support IE preview and configure DVR via browser.
- Support SADP protocol that enables modification of IP address, mask and port via SADP Client.
- Support remote log query.

Development supports

- Provide network SDK.
- Provide client demo source code.

Chapter2 Installation

Warning: Before you installing the DVR, please make sure the power of DVR is switched off.

2.1 Checking the DVR and Its Accessories

When you get the product, check that all the items are included in your product package. There is a list in the package. If any of the items is missing, please contact your dealer.

2.2 HDD Installation

Installation notice

A factory recommended HDD should be used for this device.

The DVR has no HDDs when leaving factory. Based on the record schedule, you can calculate the total capacity you need (refer to Appendix A). Please ask the specialist to disassembly the DVR and install HDD.

Installation instrument

One cross screw driver

HDD installation

1. Open the DVR box.
2. If you want to install 4 HDD, please remove CD-R/W mount bracket.
3. Place the HDD on the soleplate and fix it with screw.
4. Connect the SATA data cable correctly.
5. Plug the HDD power connector.
6. Cover and fix the DVR box.

Note: After you install the HDD, you must format them. Please refer to section 6.4.

2.3 Rear Panel Description

Notice: Please refer to real product for different model.

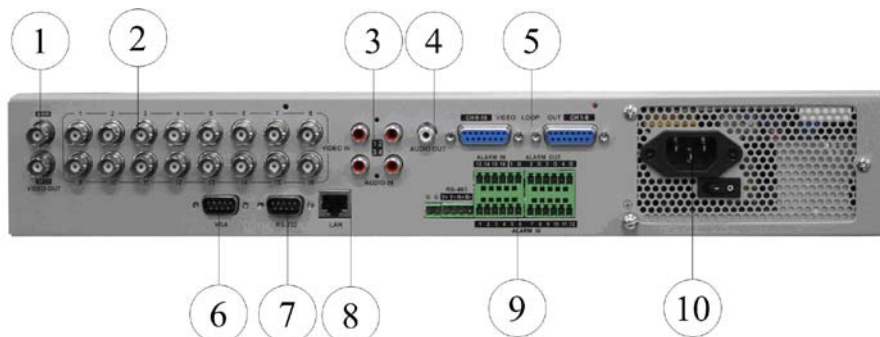

Index	Physical Interface	Description
1	Video Output (main & spot)	Standard BNC.
2	Video Input	Standard BNC, connect to camera
3	Audio input	4 channel RCA (1.0 Vp-p, 75Ω)
4	Audio Output	1 channel RCA (1.0 Vp-p, 75Ω)
5	Video Loop out	DS-7016HI-S uses DB15 connectors. DS-7004HI-S uses on board BNC connectors.
6	VGA Interface	VGA display.
7	RS-232	Connect RS-232 devices. Refer to Appendix B for pin definition.
8	LAN Interface	Connect network devices. Refer to Appendix B for pin definition.
9	RS-485	PTZ connection. Refer to Appendix B for pin definition.
	External Alarm Input	4/16 Alarm in.
	Relay Output	2/4 Alarm out
10	AC Input	100V~240VAC

2.4 External Alarm In/Out Connection

Alarm input port:

G (GND): Conenct the GND of sensor.

1~16: Alarm input, supports normal open/normal close.

0: Reserved.

Alarm output:

1G~4G: 4 relay output.

Alarm output connection

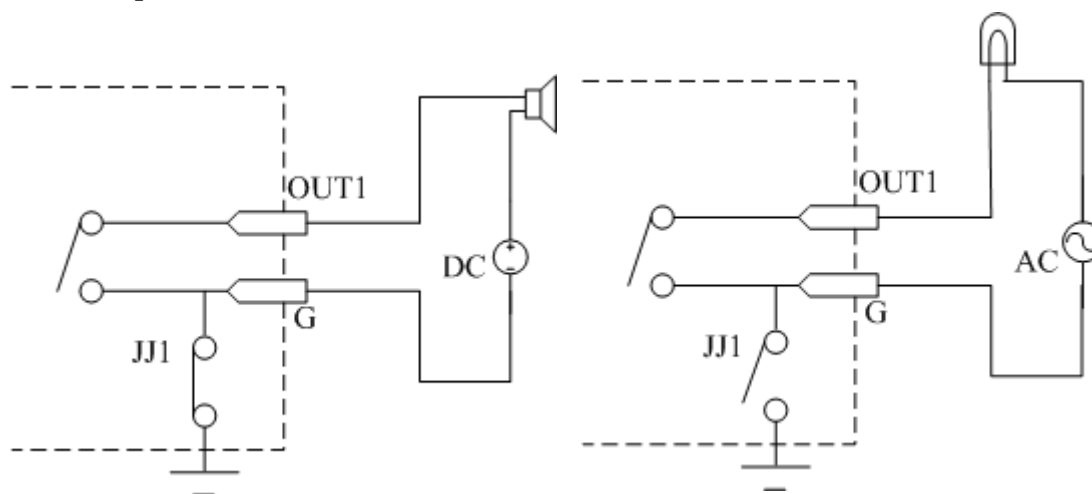

Please note the usage of jumper JJ1. If you use DC, either of connections is OK. We suggest you to use those DC under 12V, 1A.

If you use AC, please open the jumper. There are 4 jumpers (JJ1, JJ2, JJ3 and JJ4) in DVR main board, corresponding with 4 alarm output. The default is closed.

Warning: If you use AC input for relay output, please open the jumpers.

Chapter3 Operational Instructions

3.1 Front Panel



Index	Type	Name	Description
1	State Lamps	READY STATUS ALARM RECORD NETWORK	DVR is ready. Green means you can use IR remote control. Red means there is an alarm. Twinkling red means reading or writing HDD. Network status.
2	Lamp		IR receiver.
3	Numeric Keys		Input number, lower case, upper case character and symbols.
	Function Keys	MENU	<ol style="list-style-type: none"> Switch from preview mode to the main menu; Brush control short key [WIPER]. Press [MENU] for more than 5 seconds to cancel button beep sound.
		2	[ZOOM-] in PTZ control, SPOT switch button
		3	[ZOOM+] in PTZ control.
		ESC	Cancel and back to parent menu.
		EDIT	<ol style="list-style-type: none"> In edit state, delete the current cursor character; [IRIS+]in PTZ control; Select ✓ or × to enable or disable.
		PLAY	<ol style="list-style-type: none"> Local playback; [AUTO] in PTZ control.
		REC	<ol style="list-style-type: none"> Manual record; [SHOT] in PTZ control (adjust preset).
PTZ	<ol style="list-style-type: none"> Enter PTZ control mode; [IRIS-] in PTZ control.. 		
PREV	<ol style="list-style-type: none"> Multi screen preview switch; Switch from menu mode to preview mode; 		
A	[FOCUS-] in PTZ control.		

		SHIFT	<ol style="list-style-type: none"> 1. Input switch (number, lower case, upper case and symbol); 2. [FOCUS+]in PTZ control; 3. In preview mode, display or hide the channel status bar. <p>Switch between numeric keys and function keys</p>
4	Control Keys	<p>Direction Keys</p> <p>ENTER</p>	<p>Composed of [↑],[↓],[←] and [→].</p> <ol style="list-style-type: none"> 1. Menu mode, use[←]/[→] select,[↑]/[↓] to edit; 2. PTZ direction control; 3. Playback speed control. <ol style="list-style-type: none"> 1. Menu confirmation; 2. Select ✓ or × to enable or disable; 3. Pause playback.
5	POWER	POWER	Device on-off and power indicator lamp. Green means DVR is working; Red means DVR is power-off; No light means no power.

Please note that [SHIFT] button is used for switching between numeric keys and function keys.

3.2IR Remote control



Index	Name	Description
1	POWER	Turnoff device.
2	DEV	Enable/Disable IR remote control
3	Numeric Keys	Same as numeric keys of front panel.
4	EDIT	Same as EDIT key of front panel.
5	A	Same as A key of front panel.
6	REC	Same as REC key of front panel.
7	PLAY	Same as PLAY key of front panel.
8	INFO	Reserved
9	VOIP	Reserved
10	MENU	Same as MENU key of front panel.
11	PREV	Same as PREV key of front panel.
12	Direction Keys ENTER	Same as direction keys and enter key of front panel.
13	PTZ	Same PTZ key of front panel.
14	ESC	Same as ESC key of front panel.

15	Reserved	
16	F1	Reserved
17	Lens control	IRIS, FOCUS ZOOM for lens control.
18	F2	Reserved

Loading the batteries into the IR remote control

1. Remove the battery cover.
2. Insert the battery. Please take care that the poles (+ and -) are correctly positioned.
3. Replace the battery cover.

Start to use IR remote control

Press [DEV] key, input the DVR device ID (default is “88” that can be changed in “Display” menu) and then press [ENTER] key. If the “STATUS” lamp of DVR front panel is turned into green, it means you can use IR remote control to operate this DVR.

Note: If the device ID is set as “255”, you can control the device by IR remote control without any operations. The STATUS lamp will go out by then.

Stop using IR remote control

When IR remote control status is on, press [DEV] key again, the “STATUS” lamp will go out. The IR remote control can not control this DVR.

Switch the DVR off

When IR remote control status is on, press [POWER] key for several seconds, the Power Off prompt will pop up, confirm and the DVR will be power-off in progress.

When IR remote control can not work normally

- Check batteries poles.
- Check the charge left in the batteries.
- Check IR remote control sensor is mask.

Please change another IR remote control to try again. If the problem still exists, please contact your dealer.

3.3 Menu Description

3.3.1 Menu Items

Menu Name	Function	Menu Name	Function
Display	Unit name Device ID Require password Screen saver Video standard Enable scaler Brightness Menu transparency VGA resolution DST Date and Time	Image	Select camera Camera name & Position Brightness, Contrast, Hue & Saturation Adjust OSD & Position Privacy Mask & Area View tampering, Area & Policy Signal loss & Policy Motion Det. Level, Area & Policy
Recording	If HD full & SATA1 Disk Select Camera & Record Para. Stream Type, Resolution, Frame Rate, Max Bit Rate, Image Quality & Bit Rate Type Enable EventPara & Enable Rec Schedule PreRec time & PostRec time Copy to Camera	Network	NIC Type, IP, Mac & Port Advanced setup, DNS IP, Mask & Gateway Multicast IP Remote host IP & Port NAS Setting httpPort, PPPoE E-mail Setup
Alarms	Select Alarm In Alarm Type (N.O/ N.C) Alarm Handling & PTZ linkage Copy to Alarm In Alarm Out, Delay Time & Schedule	Exceptions	Exceptions Handle Method Audible Warning Upload to Center Trigger Alarm Out Send Email
PTZ	Select Camera PTZ parameters Preset setup Sequence setup Cruise setup	RS232	RS232 parameters RS232 work mode Callback & Data Encryption
Preview	Preview mode Select Out Switch Time Enable/Disable audio preview	User	Add or delete user Password setup or modification User rights setup

	Alarm Aux Out Display Delay Layout		
Transact	Transaction Information Get Through Options	Utilities	Save Para. Restore Para. Upgrade firmware HDD management Stop alarm output Reboot Power off View log System information

3.3.2 Menu Operation

How to enter menu mode

- Press [MENU] key to enter DVR main menu.
- Press [PLAY] short key to enter playback menu.
- Press [REC] short key to enter manual record menu.
- Press [PTZ] short key to enter PTZ control interface.

Notes: You must input user name and password. The default user name is “admin” and password is “12345”.

Main Menu Description

The main menu interface is following:



There is one small rectangular frame named “Active Frame”. It can be moved from one icon to another by using [→]or[←]key. When the “Active Frame” is located on one icon, you can press[ENTER]key to enter the secondary menu. For example, move the “Active Frame” to “Image” icon, press [ENTER]to enter the secondary menu as follows:

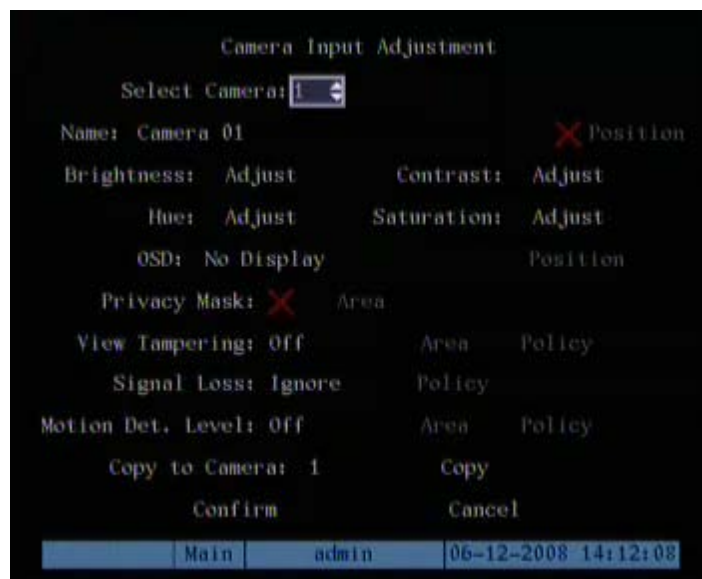

Each menu contains different kinds of items. There is a small rectangular frame named “Active Frame” which is pointing to the selected item. This “Active Frame” can be moved by [→]or[←]keys. There are such kinds of menu items:

1. Check Box: Provide 2 options, “✓” means enable and “x” means disable. You can use [ENTER]or[EDIT]key to switch over.
2. List Box: Provide more than 2 options. However, only one of them can be selected. You can use [↑]and [↓]to select one option. For example, on the right side of “Select Camera”, there is a list box for you to select one camera.
3. Edit Box: This is for you to input characters. Press [EDIT]key to enter edit status, you can input characters as follows:
 - a) Press [A]key to select number, upper case, lower case or symbols;
 - b) Use [→]and [←]keys to move cursor;
 - c) Use [EDIT]key to delete the character in front of cursor;
 - d) Press [ENTER]or [ESC]to exit edit.
4. Button: Execute a special function or enter next sub-menu. For example, press “Policy” button to enter sub-menu. Press [Confirm]to save parameters and return to parent menu. Press [Cancel]button to cancel and return to parent menu. The button in grey means it can be operated only after it is enabled.

How to exit menu

Press [PREV]key to exit menu and return to preview mode.

3.4 Character Input

In the menu interface, if you enter edit status (for example, in the “camera name” edit box), at the bottom of screen, the input status is appeared:

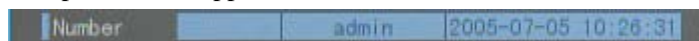

Here it means you can press numeric keys to input digital number.

Press[A]key to change input methods. You can select “number”, “Uppercase”, “Lowercase” or “Symbol”.

Uppercase

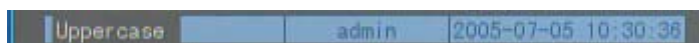

Lowercase

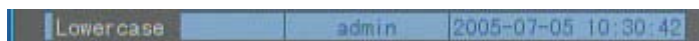

Symbol



There are 24 symbols in all. They are divided into 4 pages, and you can use[0]key to turn over page.

Chapter4 Basic Operation Guide

4.1 Power on

Note: Please make sure the power supply matches DVR and AC cable connected correctly. Before switch DVR on, please connect one monitor with VOUT or VGA interface. Otherwise, you can not see graphic user interface and can not operate.

If[POWER]lamp is off, please do as follows:

Step1: Connect AC cable correctly;

Step2: Switch on the power button on the real panel.

If[POWER]lamp is in red, just press[POWER]button to start DVR.

When DVR is started,[POWER]lamp is in green. On the monitor or VGA display, DSP and HDD initialization process will be shown.

The first line represents DSP initialization. If the DSP icon is “×”, it means that the DSP is initialized error, please contact administrator at once.

The second line represents HDD initialization. If the HDD icon is “×”, it means the corresponding HDD is not installed or not detected. If HDD is not detected, please contact administrator.

Note: If HDD is not installed or not detected, DVR will beep for alarm. You can disable the alarm option in “Exceptions” menu.

4.2 Preview

4.2.1 Main Preview

DVR will enter preview mode after it is started.

On preview screen, you can see date, time, camera name and camera status icon.

Set system date and time in “Display” menu, referring to 5.2.9; Change camera name in “Image” menu, referring to 5.3.2.

On the screen, it will display record and alarm status of each camera. These two kinds of status will switch over automatically.

Press[A]key to display or hide the camera status bar.

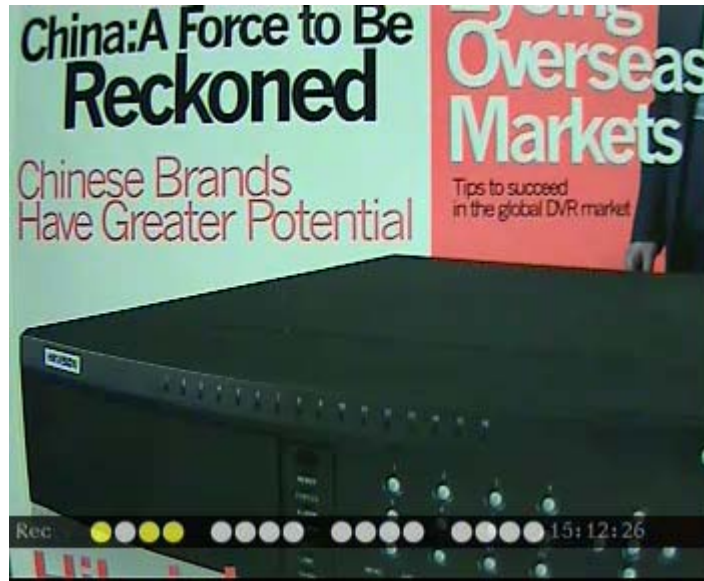





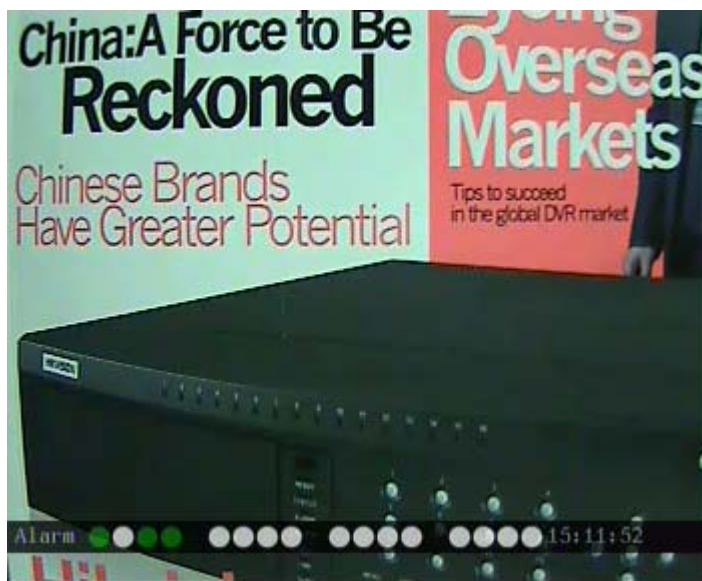

Camera record status is following:

Icon	Icon Color	Status Description
①	White	No video signal
●	Yellow	Vdideo input
●	Pink	Manual recording
●	Green	Real time recording
●	Blue	Motion detect recording
●	Red	External alarm recording



Camera alarm status is following:

Icon	Icon Color	Status Description
	White	Video signal lost
	Yellow	View tampering alarm
	Pink	Motion&External alarm
	Green	No alarm
	Blue	Motion alarm
	Red	External alarm

Press numeric keys to switch over individual camera preview. If DVR has less than 10 channels, press one numeric key to switch corresponding channel. For example, press [2]key to preview 2nd camera. **If DVR has 10 or more than 10 channels, press two numeric keys to switch corresponding channel. For example, press [0][2]to preview 2nd camera; and press [1][2]keys to preview 12th camera.**

Press [EDIT]key to manual cycle preview. **You can set the auto preview mode in “Preview” menu, referring to 5.11.**

Press [PREV]key to switch multi-screen preview.

4.2.2 Spot Preview

The spot output is an additional composite monitor used for preview operations.

Press button “2” on the front panel to control spot out, press “shift” button to switch button function into numeric button, press channel number to switch spot out channels.

Notes: 1.If there is no video input; you can't preview anything under the spot out mode.

2. The spot out supports single screen preview only.

4.3 User name and password

Note: When DVR is delivered from factory, there is only one default administrator named “admin”, and password is “12345”. The administrator’s name can not be modified, while the password can be modified. The administrator can create 15 users and define their user rights.

Login

Login dialog is following:

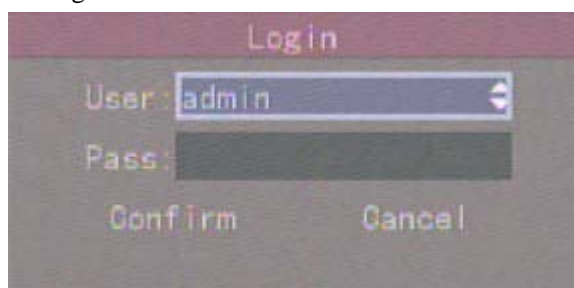

Use[↑]/[↓]keys to select one user, press[→]key to enter “Password” edit box, input corresponding password, press[ENTER]key to exit edit box. The “Active Frame” will be moved to “Confirm” button. Press[ENTER]key to enter main menu. If there is beeper alarm, it means the user name and password are not matched. After three error times, DVR will enter preview mode.

Modify password

For those users created by admin, they can modify their password as follows:

Step1: Enter main menu

Press[MENU]key, in the login dialog, select your user name, input the correct password, you can enter the main menu.

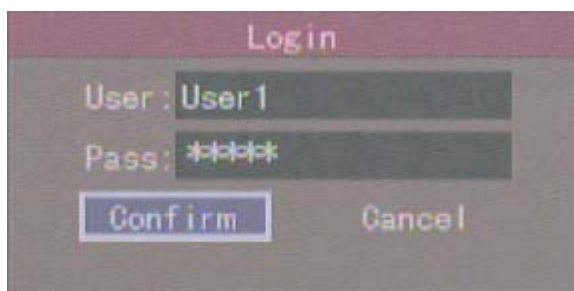



Setp 2: Enter User menu

Move the “Active Frame” to “User” icon by using[→]/[←]keys. Press[ENTER]key to enter following password menu:

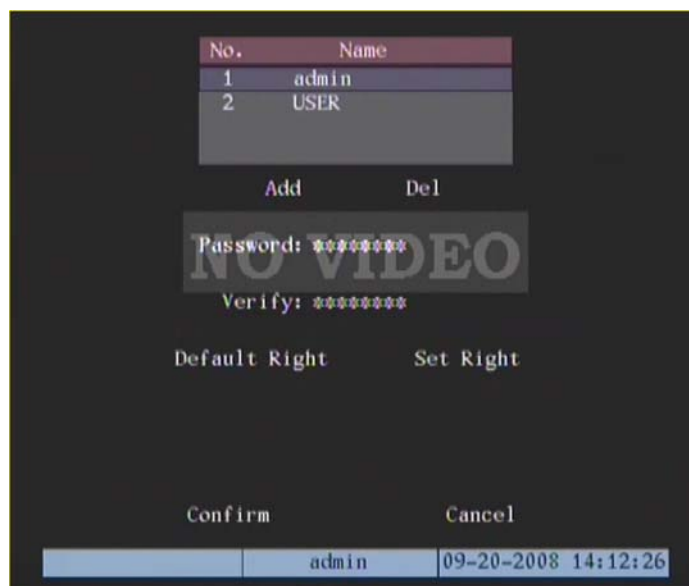

Step 3: Input new password

Press[EDIT]key to enter edit box. You can use numeric keys to input new password. The password can be null. It also can be 16 numerals. Press[ENTER]to exit edit box, and move to “Verify” item to input the verify password.

Note: In edit box, use [→]/[←]to move cursor and[EDIT]key to delete the numeral in front of the cursor.

Step 4: Modify password successfully

Move the “Active Frame” to “Confirm” button, press[ENTER]key. If the password is modified successfully, you will get the main menu or an error dialog will be pop up. You can repeat step 3 to modify again.

4.4 PTZ Control

Note: The user must have the “PTZ control” right.

PTZ control interface

In preview mode, press [PTZ]key, in the login dialog, select one user name and input the correct password, you can enter PTZ control interface.

In menu mode, press [PTZ]key, you can enter PTZ control interface directly.

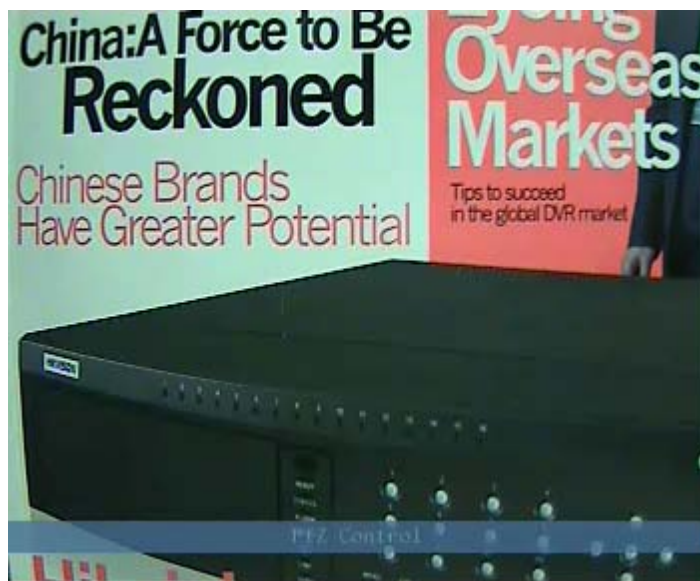

There is “PTZ Control” prompt in the PTZ control interface. The displayed camera name means which channel’s PTZ is under control. For example, “Camera 01” means you are controlling the 1st camera PTZ.

Select channel

In PTZ control mode, you can press numeric keys to select channel. If DVR has less than 10 channels, press one numeric key to select. For example, press[2]key to select 2nd camera PTZ. **If DVR has 10 or more than 10 channels, you must press two numeric keys to select. For example, press[0][2]to select 2nd camera PTZ, and press[1][2]to select 12th camera PTZ.**

After you select the camera PTZ, you can use the short keys to control PTZ.

PTZ control keys description

Direction control keys: [↑],[↓],[←],[→];
 ZOOM control keys: [ZOOM+],[ZOOM-];
 FOCUS control keys: [FOCUS+],[FOCUS-];
 IRIS control keys: [IRIS+],[IRIS-];
 Adjust preset keys: [REC/SHOT];
 Auto control key: [PLAY/AUTO];

Wiper control key: [WIPER/MENU];

Light control key: [LIGHT/F1];

Auxiliary device control key:[AUX/F2]

Adjust preset description

In PTZ control mode, press[REC/SHOT]key, and press the preset number (three numeric keys), DVR will adjust the corresponding preset number. Repeat pressing[REC/SHOT]key, and press the preset number, DVR will adjust that preset number.

When you exit PTZ control mode, the camera will stay at the current position.

Note: The PTZ preset number is set already. Please refer to PTZ menu for preset setup. V1.4 firmware can support 128 preset numbers at most.

Start/Stop auto in PTZ control mode

In PTZ control mode, press[PLAY/AUTO]key to start PTZ auto function. Press[PLAY/AUTO]key again to stop.

When PTZ is in auto mode, if you exit PTZ control mode, PTZ will continue auto function. You must enter PTZ control mode again, and press[PLAY/AUTO]key to stop.

Exit PTZ control mode

Press[ESC]or[ENTER]to exit and return preview mode.

4.5 Manual Record

Note: The user must have the corresponding right, DVR has HDD and HDD is formatted already.

Manual record

In preview mode, press[REC]key, in the pop-up login dialog, select the name and input the correct password, you can enter the “Manual Record” interface.

In menu mode, press[REC]key to enter “Manual Record” interface directly.

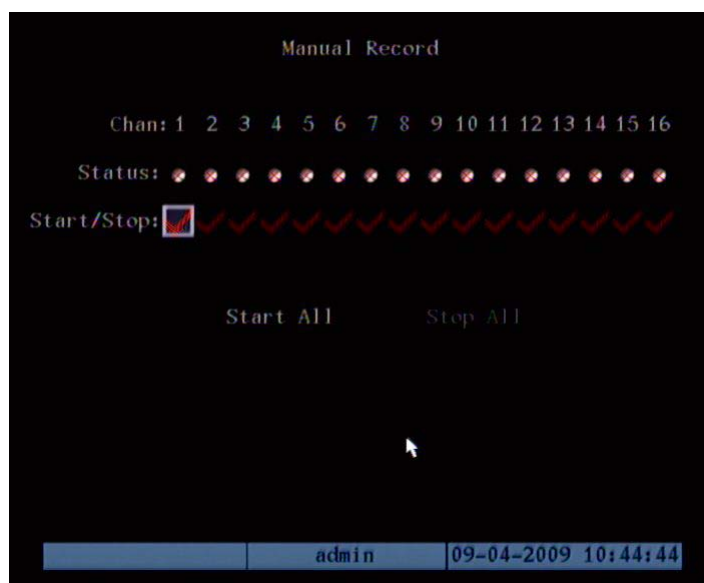

Description

Manual record interface has follows parts: channel number, channel status, start/stop record, start all and stop all buttons.

Channel: List the channel number that DVR has.

Status: Channel work status has 4 cases:  means idle. Green means the channel is recording (including real time recording, alarm recording, motion detection recording). Red means network transmission. Orange means both recording and network transmission.

Start/Stop: “✓” means you can start corresponding channel recording. “x” means you can stop recording.

Start All: Press this button to start all channels recording.

Stop All: Press this button to stop all channel recording.

Exit manual record

Press[ESC]key to enter preview mode. Press[MENU]key to enter main menu. Press[PLAY]key to enter playback menu. Press[PTZ]key to enter PTZ control mode.

4.6 Playback

Note: The user must have “Playback” right.

Playback interface

In preview mode, press[PLAY]key, in the pop-up login dialog, select username and input correct password, you can enter “Playback” interface.

In menu mode, press[PLAY]key, you can enter “Playback” interface directly.

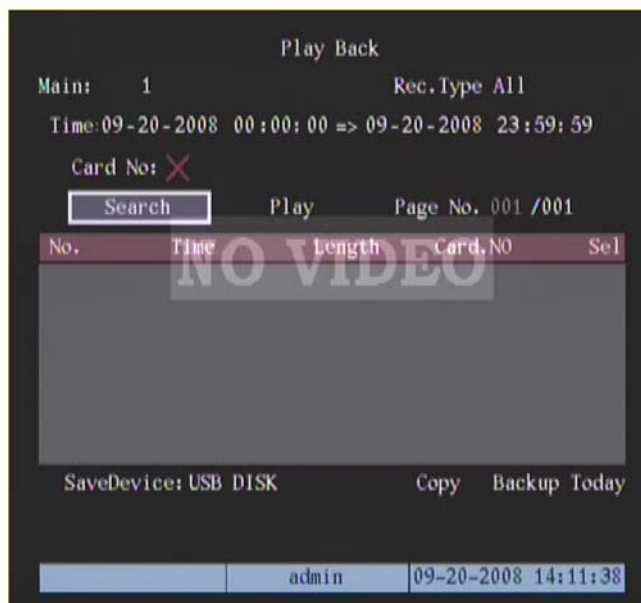

Playback

Description

This series DVR only supports one channel playback,

MAIN: Use[↑]or[↓]key to select one channel.

Rec Type: Use[↑]or[↓]to select recorded files type. The file type options have “All”, “All Time”, “Motion Detect”, “Alarm” and “Manual”.

Time Section: You can define the search time section. Move “Active Frame” to the time edit box, use numeric keys to input the detail time.

Card Number: DVR can get text number through RS-232 or network port. The text is sent from devices such as ATM machine, POS machine or others. DVR can overlay the text on the real time image and record. You can use the text to search the recorded files and playback them. Use the numeric keys to input the text number.

Search: Search the matched reorded files and display them in the list box. If there is not

matched file, a corresponding dialog box will be pop-up.

Play by Time: Playback the recorded stream directly based on the time section.

Select Page: In the file list box, each page will only display 8 files. If the matched files are more than 8, you can select page to list other files. 500 pages (4000 files) can be searched in one time. You can use numeric keys or [↑][↓]keys to select page.

File List Box: List the matched files. File started time, file size are displayed in the list box. You can use [↑][↓]keys to move the scroll bar to select file.

Backup Devices: You can select USB DISK, SATA HD, USB HDD, USB CD-R/W or SATA CD-R/W to backup the files or clips.

Copy: Start to backup.

Backup Today: Backup all recorded files of today.

Three kinds of playback mode

1. Search and playbck file: In the playback interface, you can select main channel, second channel (2-ch palyback), record type, time section. Move “Active Frame” to “Search” button and press[ENTER]key, DVR will search and list the matched files.

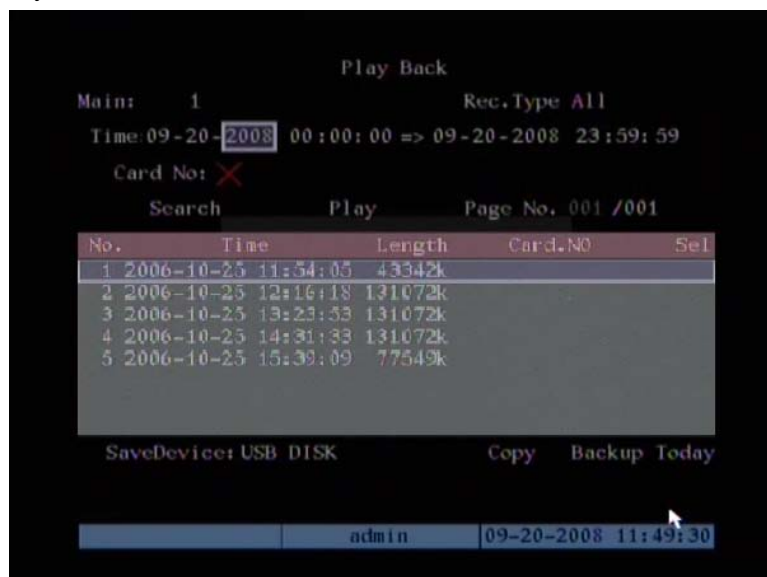

If the matched files are more than 8, you can use “Page No.” to select page (use numeric keys or [↑][↓]keys to select page). In the file list box, use [↑][↓]keys to move the scroll bar to the file, press [ENTER]key to playback the file. If the second channel is selected, these two channels can be playbak synchronously.

If DVR can not find the matched files, a failure dialog box will be pop-up.

2. Playback by Time: In the playback interface, select channel number, record type and time section, move “Active Frame” to “Play” button, press[ENTER]key, DVR will start to playback based on time section.

3. Search by Card No and Playback file: In the playback interface, select channel number, record type, enable card No. search option (“✓”) and input the card number, move “Active Frame” to “Search” button, press[ENTER]key, DVR will search and list the matched files. If the matched files are more than 8, you can use numeric keys or[↑][↓]keys to select page. Use[↑][↓]keys to move scroll bar to the file, press[ENTER]key to playback the selected file. If DVR can not find the matched files, a message dialog will be pop-up.

Operation when playback

Playback picture:

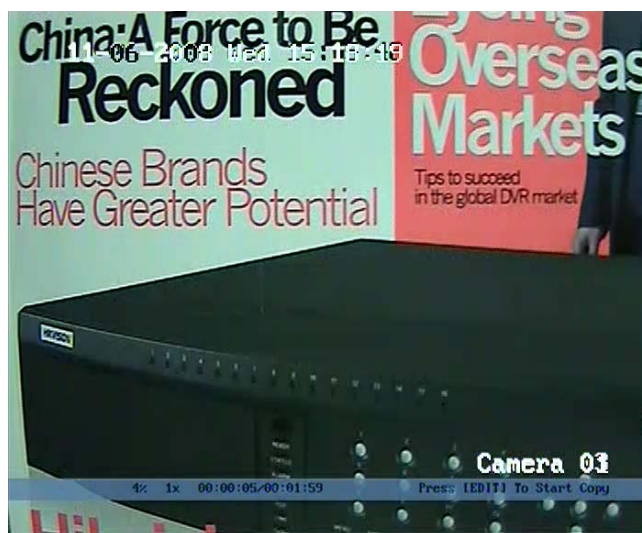

Playback

At the bottom of image, there is an information bar and the following information is included: Volume, Play Progress, Play Speed, Played Time and File Total Time.

- Display/Hide information bar: [MENU]
- Open/Close sound: [PLAY]
- Adjust play progress: [←](Backward),[→](Forward). The unit is “%”.
- Adjust play speed: Normal speed is “1x”. Use [↑]to increase play speed (2X, 4X, 8X and MAX). Use[↓]to decrease play speed (1/2X, 1/4X, 1/8X and Frame by Frame)
- Pause/Continue: Press [ENTER]to pause/continue playback. If played frame by frame, Press[ENTER]to paly one frame.
- Copy segment:[EDIT]
- Exit: [ESC]

When in the single playback mode, you can press [REC] button and use [←] [→] [↑] [↓] buttons to select an area, then press [ENTER] button, the selected area will be enlarged in 4 times.

You can press [REC] button to get back to normal playback interface.

Note: When DVR is busy, if you select high play speed, maybe there is difference for actual play speed.

Exit playback

In playback interface, press[ESC]key to enter preview mode.

In playback interface, press[MENU]key to enter main menu, press[REC]key to enter manual record, and press[PTZ]key to enter PTZ control mode.

4.7 Backup Recorded Files

Note: The user must have “Playback” right. Please connect with backup devices before you start to backup.

In the playback interface, you can backup the recorded files.

In the preview mode, press[PLAY]key, in the login dialog, select username and input the correct password, you can enter the playback interface.

In the menu mode, just press[PLAY]key, you can enter playback interface directly.

Backup intraday recorded files

In the playback interface, move “Active Frame” to “Backup Today” button, press[ENTER]key, all intraday recorded files of all channels will be backup to the save device. A pop-up dialog will display the backup status.

If backup device is not connected correctly or DVR do not detect the backup device, the following dialog will be pop-up. Please ask administrator for more information.



Backup the files that matched your requirement

Step 1: Search the matched files

In the playback interface, select one channel and record type, input the time section, move “Active Frame” to “Search” button, press[ENTER]key, DVR will start to find and list the matched files.

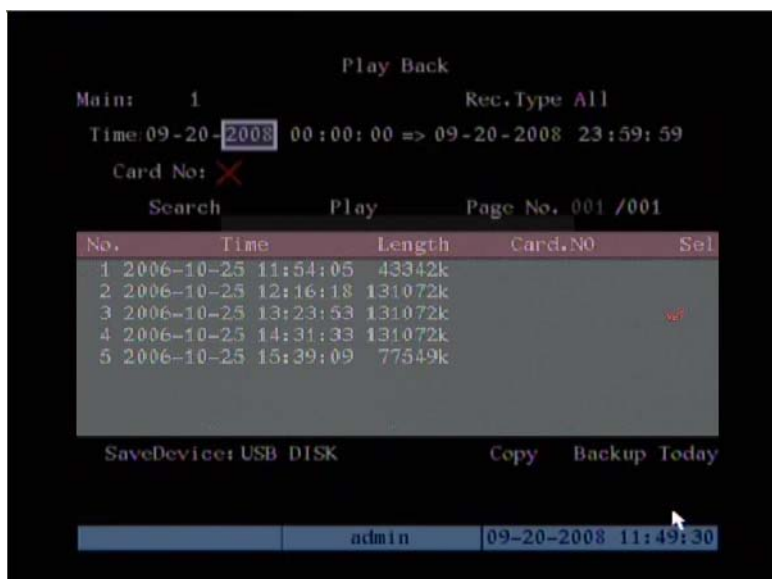

Step 2: Select the files that you want to backup

In the file list box, use[↑]or[↓]keys to move the scroll bar. When the scroll bar stays at the file you want to backup, press[EDIT]key to select it. The symbol “✓” is the selection tag. You can use the same method to select other files you want to backup. After finish, you can do next step.

Step 3: Select backup device

Please confirm the backup device: USB DISK, SATA HD, USB HDD, USB CD-R/W or SATA CD-R/W, and select the corresponding backup device.

Step 4: Start and finish backup

Move “Active Frame” to “Save” button and press[ENTER]key to start backup.

When backup is started, corresponding message box will pop-up to indicate the result.

Backup video segment

You also can backup the image segments when the image is being playback. The steps are:

- 1) Enter the interface of playback the files or playback by time;
- 2) Press[EDIT]key to start selecting the current playback image, and press[EDIT]again to stop selecting. This segment is selected;
- 3) You can repeat step 2 to select many segments. 30 segments can be selected in all;
- 4) After you select all segments, press[ESC]key, a message window will pop-up. If you press “Confirm” button, DVR will start to backup the selected segments. If you press “Cancel” button, DVR will abort backup.

Note: The backup function is effective when two channels are playback synchronously. In such case, each channel can backup 30 segments so 60 segments can be backup for two channels.

Auto Backup:

Notes:

- a) SATA HDD for auto backup needs to be connected to the 1st SATA interface;
 - b) SATA HDD for auto backup needs to be formatted by selecting “format” in the auto backup menu instead of in the HDD management menu.
1. First please enter “Recording” menu, select “Backup” for SATA1 Disk, then confirm and restart the device to make the parameter become effective; shown as figure below:



2. Then you'll find “Backup Today” turn to “Auto Backup” in the “Playback” interface; shown as figure below:



3. Select “Auto Backup” and enter the submenu shown as below:

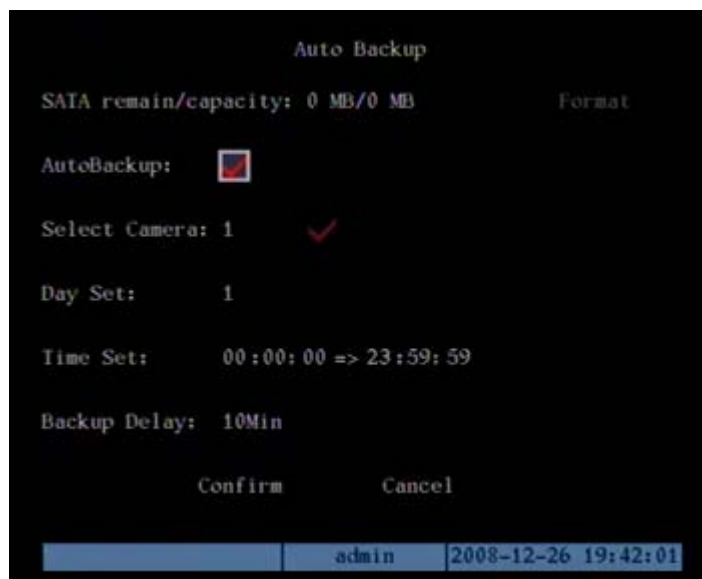

4. Enable the auto backup: Pressing “confirm” or “edit” button to enable(“✓”) or disable(“×”) the function.
5. Select camera you want to auto backup by using ▲ or ▼ button and enable(“✓”) it by pressing “confirm” or “edit”.
6. Day Set: select how many days you want to auto backup, there are options:1,2,3,4,5,6,7.
7. Time set: select the time period (only available when select 1 day). You can just input the start time and end time (hh:mm:ss).
8. Backup Delay: you can select time delay for auto backup by using ▲ or ▼ button, there are options: 0min, 10min, 20min, 30min,40,50,60,70,80,90.
9. Save the settings by pressing “Confirm” or you can cancel it if you want.

Playback the video segment

You can use our file player software to playback the video segment in PC. You can find the player software in attached CD.

Exit playback interface

Please refer to chapter 4.6.

4.8 Shut down DVR

Note: Do not switch off the power directly in case of damaging HDD. The correct step is

using “Power Off” in the “Utilities” menu, or [POWER] key on the front panel or on IR remote control.

Shut down DVR normally

Use menu

Enter “Utilities” menu, move “Active Frame” to “Power Off” button and enter power off dialog, press “Confirm” to shut down the DVR.

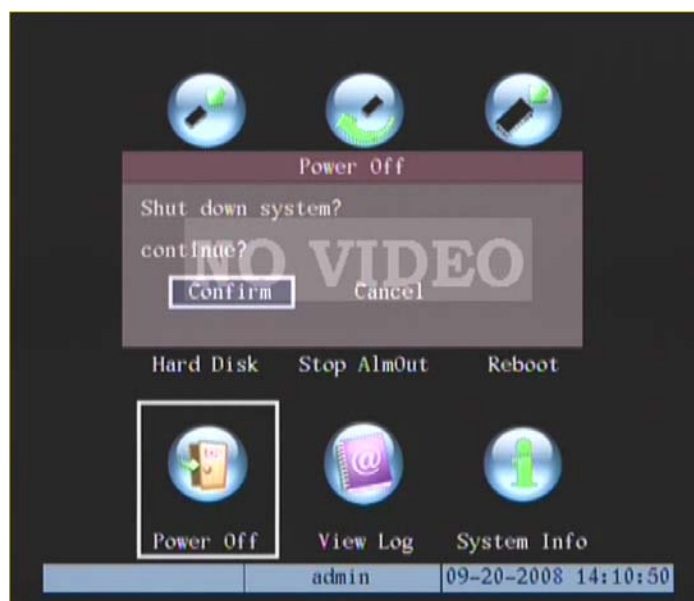

Use **[POWER]** key of front panel or IR remote control

Press[POWER]key for above 3 seconds.

In preview mode, a login dialog will pop-up, select user name and input password, press[Enter]to enter power off dialog and press “Confirm” to shut down DVR. If you input error password for three times, DVR will return preview mode.

In menu mode, if the user has “Utilities” right, you can enter power off dialog, press “Confirm” to shut down DVR. Otherwise, the user can not shut down DVR.

If DVR is shut down correctly, the[POWER]lamp is in red.

Note: When message of “Shut down...” appeared, please do not press[POWER]key any more, otherwise, DVR can not be shut down.

Shut down DVR abnormally

Use the power switch of real panel

When DVR is run, if you switch off the power, the HDD in DVR will be damaged. Please avoid such operation.

Take away the power cable

Please avoid taking away the power cable directly.

Note: In some cases, when the power supply is abnormal, DVR will be damaged. We suggest you to use those stable power supplies.

Chapter5 Parameters Setup Guide

Only the users that have “Parameters Setup” right need read this chapter. When the following parameters are modified and saved, you must reboot the DVR to make the new parameters take into effective. Other parameters do not need to reboot.

- Any network parameters
- Stream type, resolution and record schedule
- External alarm sensor type
- View tampering alarm schedule
- Video lost alarm schedule
- Motion detection alarm schedule
- External alarm schedule
- Alarm output schedule
- Transaction
- RS232 work mode
- Change video output standard

5.1 Administrator and Password

When DVR is left from factory, there is one default administrator. The name is “admin” and password is “12345”. The name can not be changed, while the password can be.

Password modification

Press[MENU]key, in the login dialog, select the username as “admin”, use[→]key, move cursor to password edit box, input “12345”, press “Confirm” to enter administrator menu.



Move “Active Frame” to “User” icon, press[ENTER]key to enter “User Management” menu.

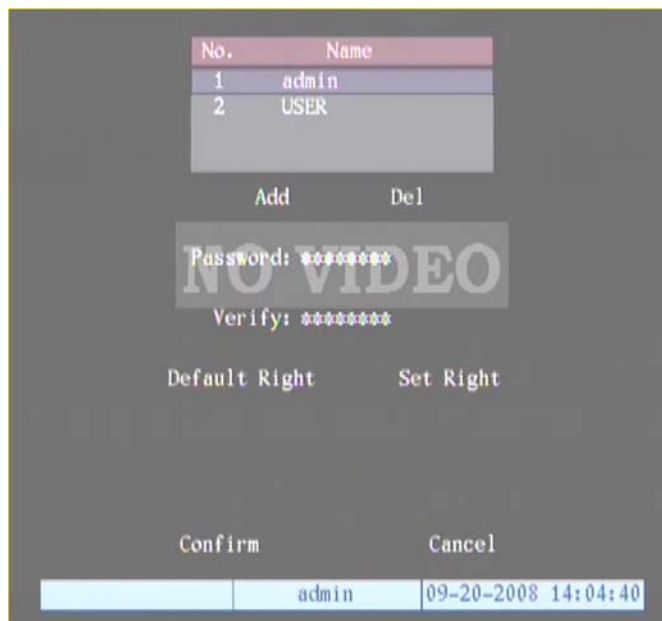

In the user name list box, only “admin” is existed. You can use[→]key, move “Active Frame” to password edit box, and press[EDIT]key to enter edit status. Press numeric keys to input the new password. The password is only combined by 16 numerals at most. After you finish inputting password, press[ENTER]key to exit. Move “Active Frame” to “Verify password” edit box, input the verify password. Move “Active Frame” to “Confirm” button, and press[ENTER], if password and verify password are the same, the password will be saved and taken into effective.

If password and verify password are not same, a warning message box will be appeared.

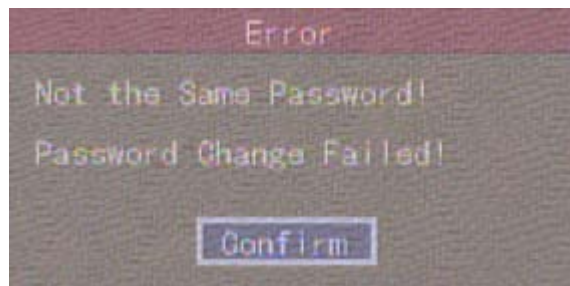

In this case, press[ENTER]to return password edit box, and input new password again.

5.2 Add and Delete User

Enter “User Management” interface.

Add user

The steps are following:

Step 1: Enter “User Management” menu

Please refer to chapter 5.1

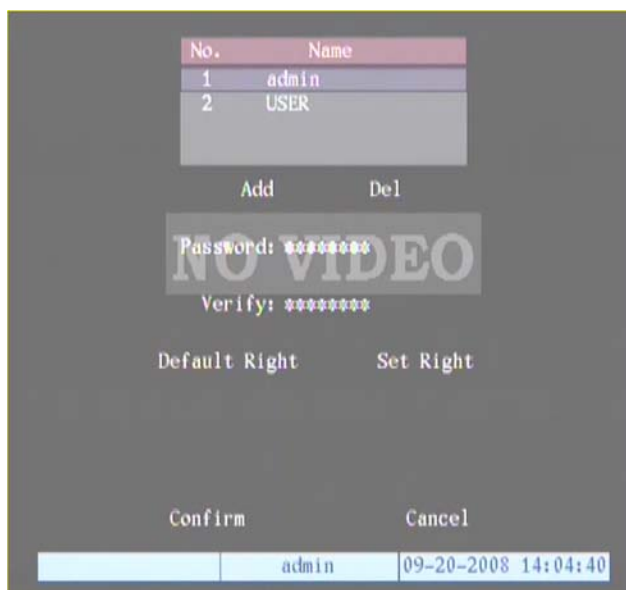

Step 2: Add new user name

In the “User Management” menu, move “Active Frame” to “Add” button and press [ENTER], in the pop-up dialog, input the new user name (refer to chapter 3.4), press [ENTER] and return “User Management” menu. 15 users can be added in all.

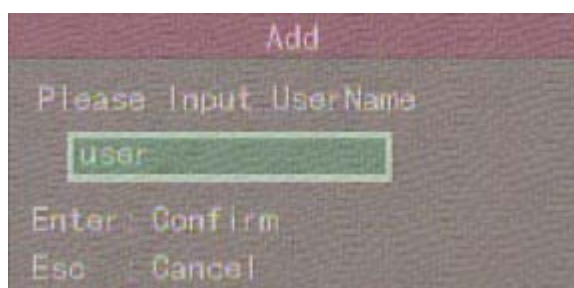

Step 3: Setup the password for new user

After you add one new user, the password is null. You can skip this step if you do not want to change the password.

In the users list box of “User Management” menu, use[↑][↓]keys to select the new user name, then use[→]key to the password edit box. Press[EDIT]key to enter edit box, use numeric keys to input the new password.

Step 3: Setup the rights for new user

The new added user has not any operational rights. You must setup rights for him.

In the users list box of “User Management” menu, use[↑][↓]keys to select the new user name, then use[→]key to “Default Rights” button, press[ENTER], the user will have the default rights. The default rights include local playback, remote playback and view log.

If you want to define the detail rights, move “Active Frame” to “Setup Rights” button and press[ENTER]to enter rights setup menu as follows:

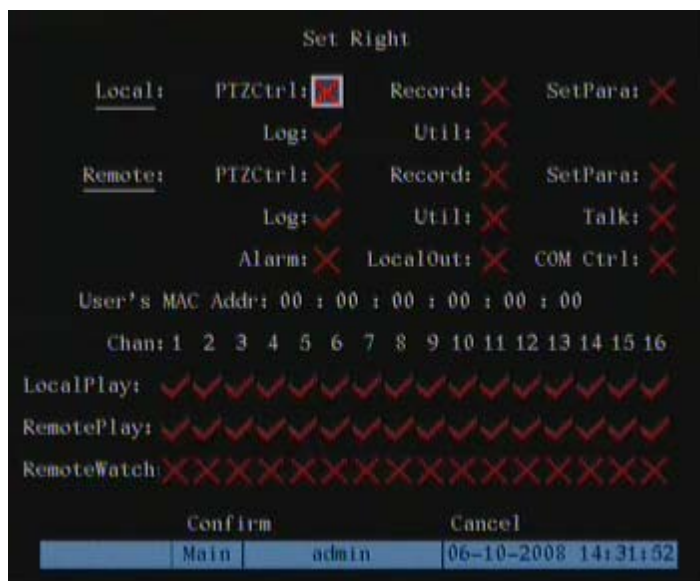

Operational rights are divided into “Local Rights” and “Remote Rights”. You can assign the necessary rights to the user. Use[→][←]key to move “Active Frame” to the corresponding right items, press[ENTER]or[EDIT]key to enable or disable the item. “✓” means designate the right to that user.

After you finish, press “Enter” button, the user’s rights will be saved and return “User Management” menu. If you press “Cancel” button, the user’s rights will be aborted.

Step 4: Save the new user’s password and rights

In the “User Management” menu, press “Confirm” button, the user’s password and rights will be saved and return main menu. If you press “Cancel” button, the user’s password and rights will be aborted.

User rights description

“Local Rights”:

Local rights are for local operation, such as the operation using front panel, IR remote control and RS-485 keyboard.

PTZ control: Locally control PTZ;
Record: Manual start/stop recording;
Playback: Local playback and backup the recorded files;
Parameters Setup: Locally setup the DVR parameters;
Log: Locally view the log on DVR;
Utilities: Locally upgrade firmware, format HDD, reboot DVR and shut down DVR, etc.

“Remote Rights”:

PTZ Control: Remote control PTZ;
Record: Remote manual start/stop recording;
Playback: Remote playback, download the recorded files on DVR;
Parameters Setup: Remote setup the DVR parameters;
Log: Remote view the log on DVR;
Utilities: Remote upgrade firmware, format HDD, reboot DVR and shut down DVR, etc.
Voice: Client talks with DVR;
Preview: Network live preview;
Alarm: Remote control DVR alarm output;
Local Video Out: Remote control DVR video output;
Com Control: DVR RS-232 transparent channel function.

MAC address

This MAC address is not the address of DVR but the PC that will access DVR. If you setup this MAC address, only the PC with this MAC address can access this DVR.

At PC end, in DOS prompt, you can use “ipconfig” command to get the PC MAC address (6 bytes).

Local Play

Administrator Can seting local playback right option for each channel for users.

Remote Play

Administrator Can seting remote playback right option for each channel for users.

Remote Watch

Administrator Can seting remote preview right option for each channel for users.

Delete user

In “User Management” interface, you can use[↑][↓]keys to select one user, then use[→], move “Active Frame” to “Del” button, press[ENTER], in the pop-up confirmation dialog, press “Confirm” button to delete the selected user and return. Press “Cancel” or[ESC]to abort deleting.

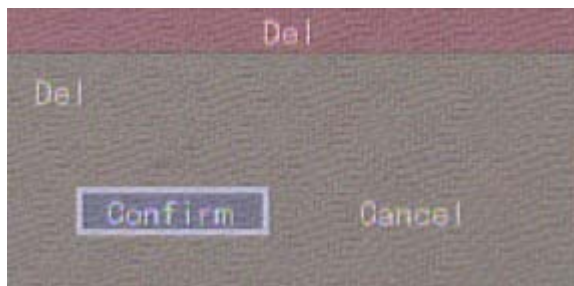

5.3 Unit Name and Device ID

Unit name

In the “Display” menu:

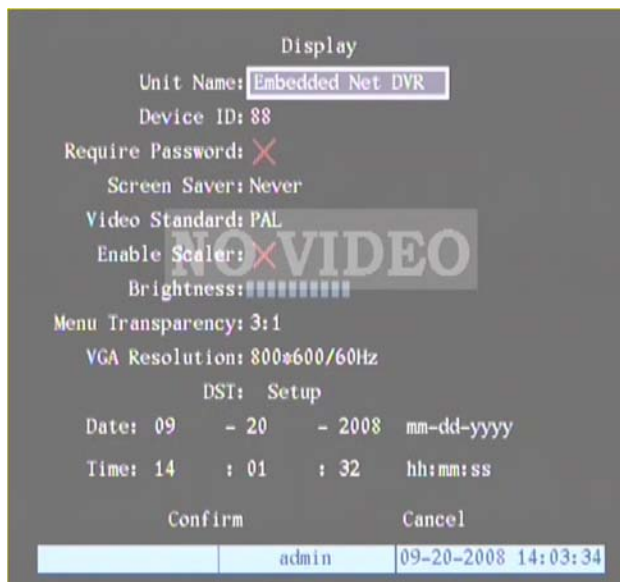

There is an item named “Unit Name”. The default unit name is “Embedded Net DVR”. Move “Active Frame” to unit name edit box, press[EDIT]key to enter edit status, you can modify the unit name. Please refer to chapter 3.4 about how to input characters. Press[ENTER]key to finish modification. Select “Confirm” button and press[ENTER], you can save the new unit name and make it into effect. Press “Cancel” button or[ESC]key to abort modification.

Device ID:

When you use IR remote control to operate DVR, you must use device ID to select DVR. The default device ID of DVR is “88”. If there are more than one DVR in one place, please define different device ID for each DVR. Otherwise, the IR remote control will control all DVR with the same device ID at the same time.

In “Display” menu, move “Active Frame” to the device ID edit box, in the edit status, you can use numeric keys to input new device ID. The device ID value is ranged among 01-100.

After you finish the modification, press “Confirm” button to save and take effect or press “Cancel” to abort modification.

5.4 Video Output Standard and VGA Setup

Video output standard

There is one VOUT BNC connector at the rear panel of DVR. It is used to connect with analog monitor and can support PAL or NTSC video output. You can modify video output standard to match video input.

In “Display” menu:

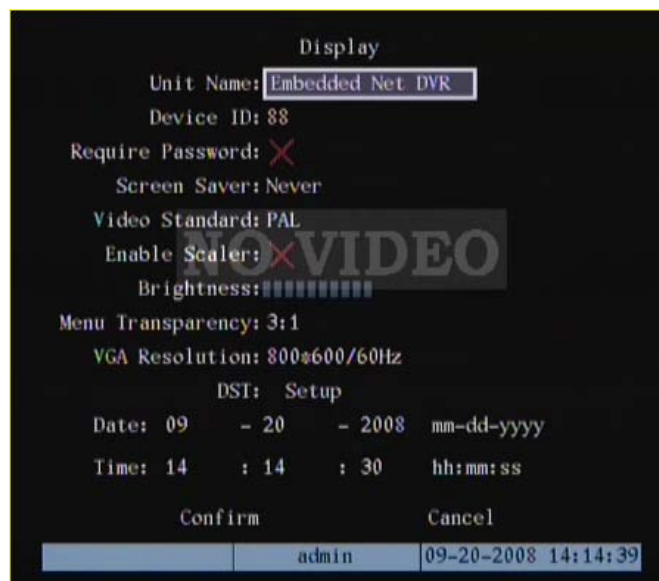

There is a list box named “Video Output Standard”, you can use[↑][↓]key to select PAL or NTSC video output.

VGA setup

There is one VGA interface at the rear panel of DVR. You can use it to connect with VGA display. You can define VGA resolution; refresh frequency in “Display” menu.

There are following options: 1024*768/60Hz, 800*600/60Hz and 800*600/75Hz. You can use[↑][↓]key to select.

Press “Confirm” button to save or “Cancel” to abort.

5.5 OSD Setup

OSD is abbreviation of “On Screen Display”. For our embedded DVRDVS, it includes displaying system time and camera name.

OSD settings include: System time, time format, time display position, camera name, camera name display position, etc.

System Time

In “Display” menu, you can setup DVR system date and time.

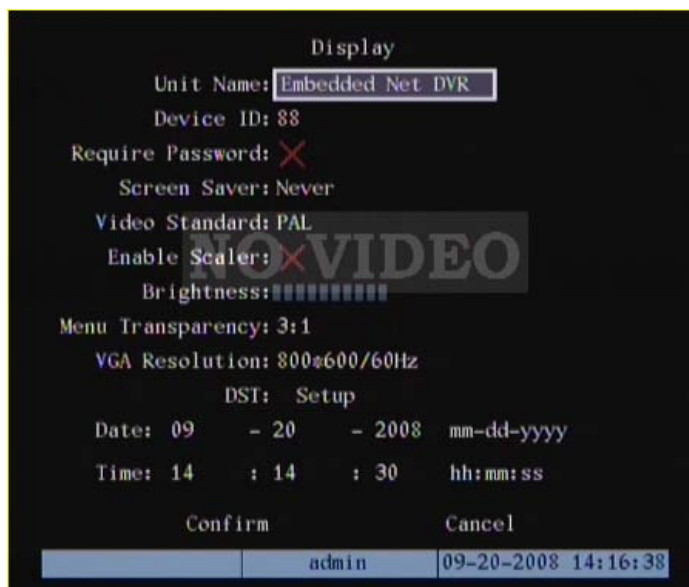

Display System Time

You can setup display properties for each camera, including display status, position and format. Of course, you can copy the properties of one camera to all cameras.

In “Image Setup” menu as follows, select one camera:

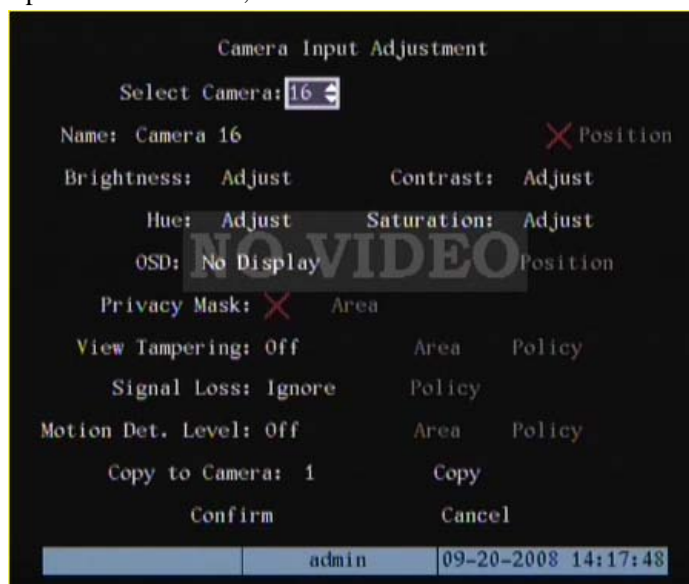

Display mode: There are several display modes: Opaque&Steady, Transparent&Steady, Transparent&Flashing, Opaque&Flashing,

Move “Active Frame” to “OSD” item, you can select one mode.

Display position and format: Move “Active Frame” to “Position” button on the right side of

“OSD”, press [ENTER] to enter setup image, you can find there are 22*18 (for NTSC, 22*15) small panes, and OSD position is in red. You can use [↓][↑][→][←] keys to move the OSD position.

Press [EDIT] key to select OSD format. There are following OSD formats:

MM DD YYYY W hh:mm:ss (default)

MM DD YYYY hh:mm:ss

DD MM YYYY hh:mm:ss

YYYY MM DD W hh:mm:ss

YYYY MM DD hh:mm:ss

Here YYYY means year, MM means month, DD means day, W means weekday, hh means hour, mm means minute and ss means second.

Press [ENTER] to save and return “Image” menu or press [ESC] to abort modification.

Copy parameters: After you setup the properties of one camera, you can copy its parameter to any other camera or all cameras.

After you save the modification, you can find the modification will be taken into effect. You can press “Cancel” button or [ESC] key to abort.

Camera Name

In “Image Setup” menu, you can define name for each camera. **Please note that camera’s name can not be copied.**

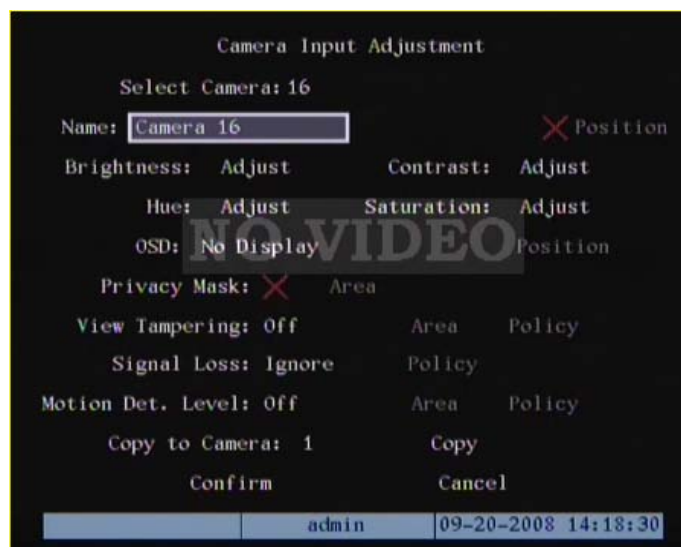

The steps of camera name setup:

Step 1: Select one camera.

Step 2: Move “Active Frame” to camera name edit box, press [EDIT] key to enter edit status, you can input digital number, uppercase and lowercase characters (refer to Chapter 3.4). The camera name can support 32 characters.

Step 3: Press[ENTER]key to exit edit status.

Move “Active Frame” to “Confirm” button, press[ENTER]to save the modification and you can see the new camera name. Press “Cancel” button or[ESC]key to abort.

Setup Camera Name Position

If you do not want to display camera name, just disable the check box beside camer name edit box. The disable flag is “x”. If you enable the check box, you can setup the camera name position. You can copy the position to any other camera. The setup stpes are:

Step 1: Enter “Image Setup” menu.

Step 2: Select one camera.

Step 3: Enable the check box on the right side of camer name, then you move “Active Frame” to “Position” button, press[ENTER]to enter camera name position setup interface, in that interface, you can use[↓][↑][→][←]keys to move camera name position. When the position is fixed, press[ENTER]and return “Image Setup” menu, and press “Confirm” button to save it. In the “Image Setup” menu, perss “Cancel” button or[ESC]key, you can abort the modification.

5.6 Video Parameters Setup

For different camera and different background, in order to get the best video image, you need to adjust video parameters such as brightness, saturation, contrast and hue, etc.

You can setup the camera individually, and also you can copy the video parameters of one camera to any other cameras. Here are the setup steps:

Step 1: Enter “Image Setup” menu:

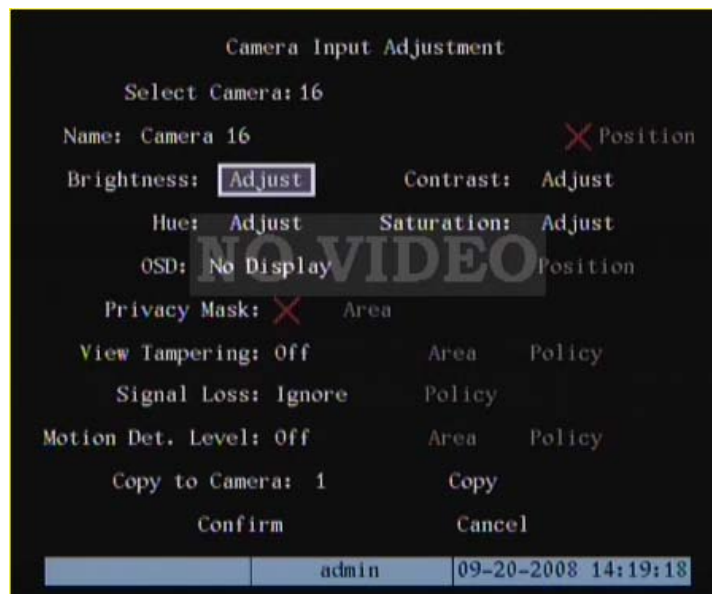

Step 2: Select camera: Please use[↑][↓]keys to select one camera.

Step 3: Adjust brightness, contrast, saturation and hue: Move “Active Frame” to the “Adjust” button on the right side of Brightness, Contrast, Saturation and Hue, press [ENTER]key, you will enter the corresponding adjust interface. In the adjust interface, there is one scroll bar at the bottom, you can use[↑][↓]keys to adjust and can find the video image will be changed at the same time. When you are satisfied with the real time video image, press[ENTER]to return “Image Setup” menu.

Step 4: You can copy the video parameters of current camera to any other cameras. Or you can repeat setp2 and step3 to adjust for any other camera.

After adjust, in “Image Setup” menu, press “Confirm” button to save parameters and make them become effective. Otherwise, perss “Cancel” button or[ESC]key to abort modification.

5.7 Mask Area Setup

In some cases, maybe you want mask the sensitive area. This area will not be preview and recorded. The mask area setup steps are following:

Step 1: Enter “Image Setup” menu:

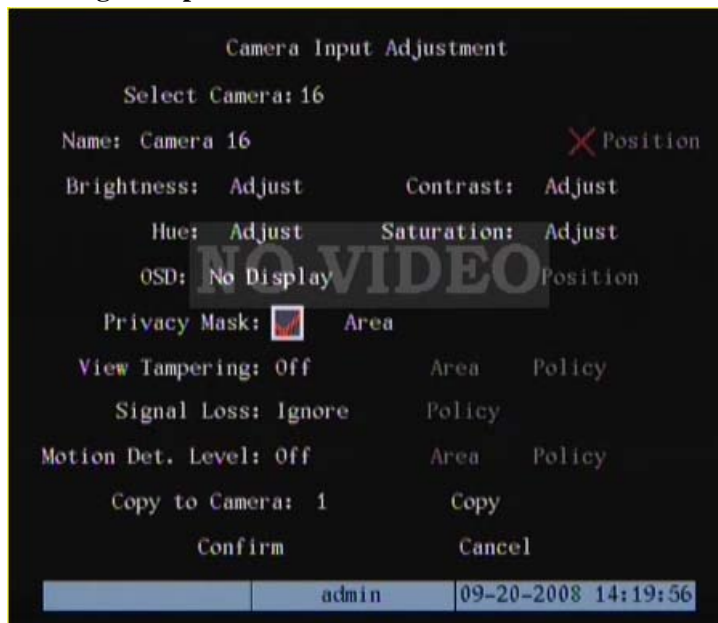

Step 2: Select one camera: You can use[↑][↓]keys to select one camera.

Step 3: Enter mask area setup interface: Enable the check box beside “Privacy Mask” item, you can press[EDIT]key to change the flag into “✓”, and active “Area” button. Move “Active Frame” to “Area” button on the right side of mask check box, press[ENTER]key to enter mask area setup interface.

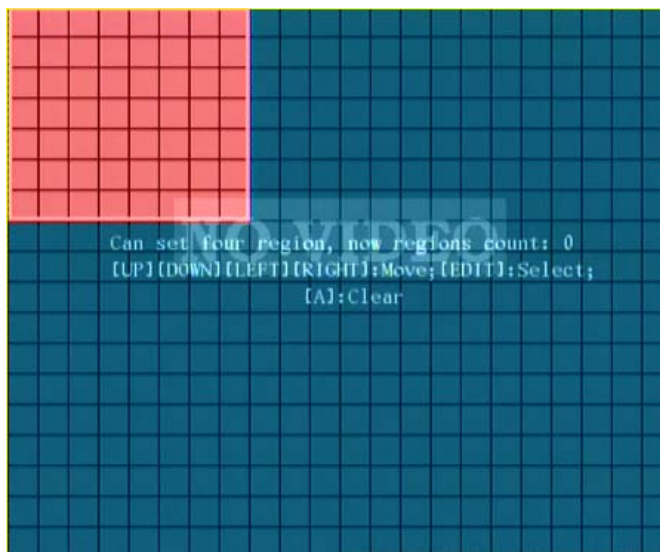

Step 4: Setup mask area: In the mask area setup interface, there is one small yellow pane on the upper left side. For PAL camera, the whole screen is divided into 22*18 panes (22*15 for NTSC), you can use[↑][↓][→][←]keys to move the yellow pane to your hope position and press[EDIT]key, the yellow pane will be turned into red, then you can use[↑][↓][→][←]keys to extend the red pane. This red area is the mask area.

After you make sure the red mask area, press[EDIT]key to save the mask area. Press[ESC]key to cancel the mask area. **The maximum mask area size is 8*8 panes and the minimum size is only one pane. You can setup 4 mask areas at most.**

After you finish setup, press[ENTER]key to return “Image Setup” menu. **You can press[A]key to clear all mask areas.**

Step 5: Save mask area: You can repeat step2, step3 and step4 to setup mask area for other cameras. In “Image Setup” menu, press “Confirm” button to save the mask area, press “Cancel” bbutton to abort.

Here is the example for mask area function.



If you disable the mask check box, you can cancel the mask area.

5.8 View Tampering Alarm

If you enable this function, when someone blocks the camera spitefully, DVR will make warning alarm.

Step 1: Enter “Image Setup” memu:

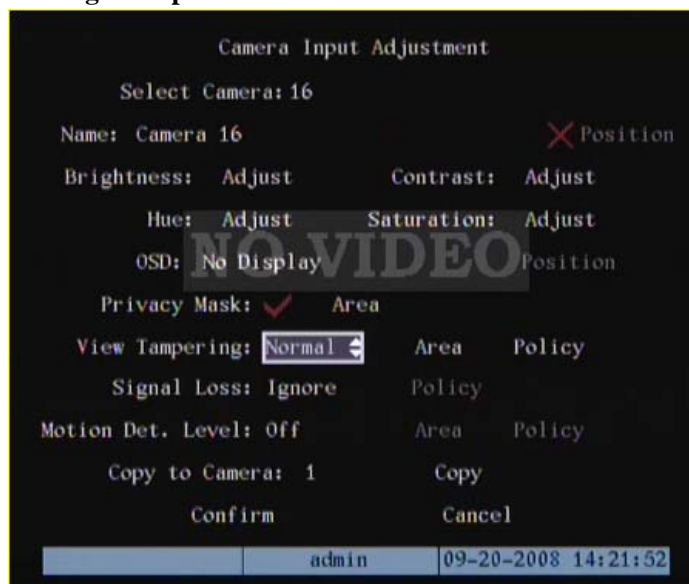

Step 2: Select camera: Please use[↑][↓]keys to select one camera.

Step 3: Select sensitivity: You can use[↑][↓]keys to select the sensitivity for “View Tampering” item. The sensitivity options are: Low, Normal and High. Select one of them will active “Area Setup” and “Policy Setup” function.

Step 4: View tampering area setup Move “Active Frame” to “Area” button, press [ENTER]key to enter area setup interface. The setup methods are same as that of mask area setup. After setup the area, press[ENTER]key to return “Image Setup” menu. You can press[ESC]key to abort.

Only one view tampering area can be setup.

Step 5: View tampering alarm setup In “Image Setup” menu, move “Active Frame” to “Policy” button, press[ENTER]key to enter “View Tampering Handle” menu:

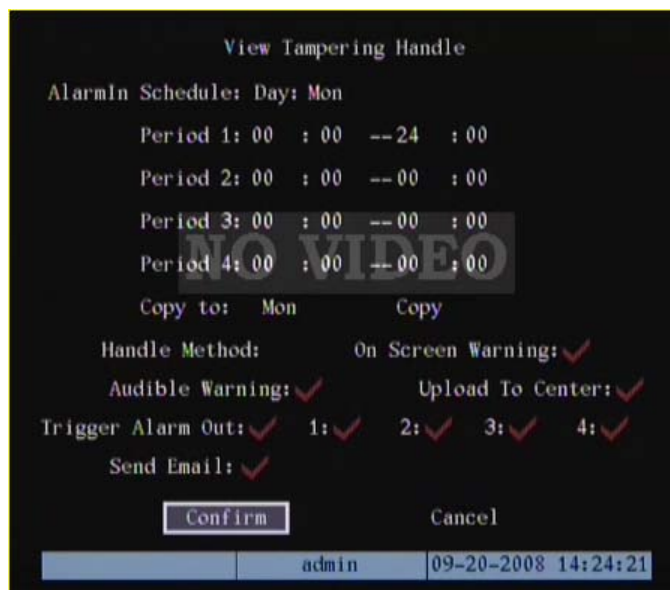

Step 6: Alarm schedule setup: When there is view tampering alarm happened, DVR will handle the alarm based on the schedule. You can set 4 periods for each day one week. Also you can copy the schedule of one day to other days.

Notes: Time periods can not be repeated. Please reboot DVR to make the parameters into effective.

Step 7: Setup alarm policy: If there is view tampering alarm happened in schedule, DVR will response based on the policy. You can select one or more solution including “On Screen Warning”, “Audible Warning”, “Upload to Center”, “Trigger Alarm Output” and “Send Email”. You can use [↑][↓] and [EDIT] key to enable or disable them. “x” is disable and “✓” is enable.

Step 8: Save alarm setup: After your setup, press “Confirm” button and return “Image Setup” interface. In “Image Setup” menu, press “Confirm” button to save current camera parameters and return main menu.

Step 9: Save all cameras: If you want to setup other cameras, please repeat from step 2 to step 8. In “Image Setup” menu, press “Confirm” key to save all cameras parameters. Press “Cancel” button or [ESC] key to abort.

Select “Off” option for “View Tampering”, you can delete the view tampering area.

Note: Only one view tampering area can be setup for each camera. The view tampering area can not be copied. If the schedule is modified, you must reboot the device to make the parameters into effective.

5.9 Video Loss Alarm

When the video cable or camera has something wrong, the video image is lost. If you enable video loss alarm, in such case, DVR will make alarm.

Step 1: Enter “Image Setup” menu:

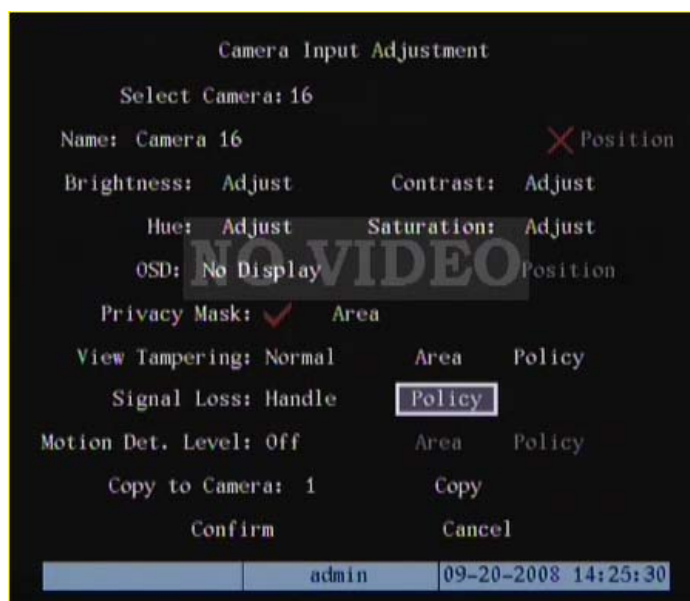

Step 2: Select camera: Use[↑][↓]keys to select one camera.

Step 3: Enter “Video Signal Loss Handle” interface: Move “Active Frame” to the list box on the right side of “Video Loss” item, use[↑]key to select “Handle” option and move “Active Frame” to the “Policy” button on right side. Press[ENTER]to enter “Video Signal Loss Handle” interface:

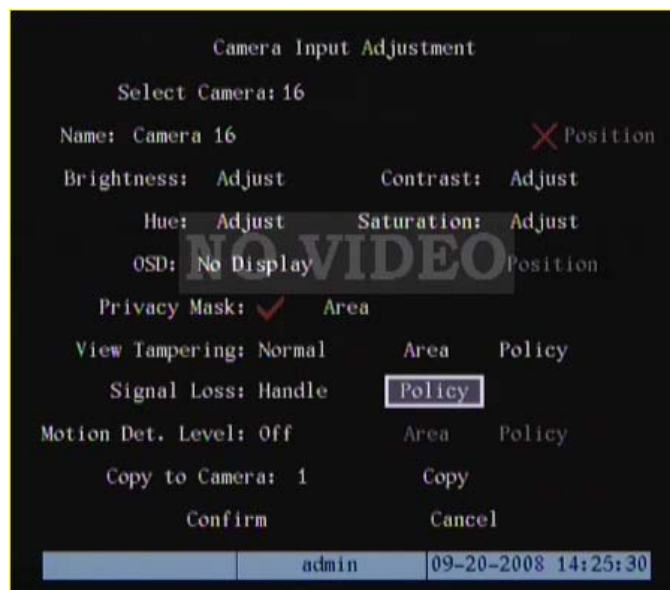

Step 4: Setup alarm schedule: You can setup working schedule. Only when the video loss is happened in the schedule, DVR will response.

Note: The 4 time periods can not be repeated. Please reboot DVR to make parameters into effective.

Step 5: Setup alarm policy: You can select one or more response solutions, including “On Screen Warning”, “Audible Warning”, “Upload to Center”, “Trigger Alarm Output” and “Send Email”. You can use [↑][↓]and [EDIT]key to enable or disable them. “×” is disable and “✓” is enable.

Step 6: Save alarm setup: After your setup, press “Confirm” button and return “Image Setup” interface. In “Image Setup” menu, press “Confirm” button to save current camera parameters and return main menu.

Step 7: Save all cameras: If you want to setup other cameras, please repeat from step2 to step 6. In “Image Setup” menu, press “Confirm” key to save all cameras parameters. Press “Cancel” button or[ESC]key to abort.

5.10 Motion Detection Alarm

If you enable this function, when there is motion detected, DVR will make alarm.

Step 1: Enter “Image Setup” menu:

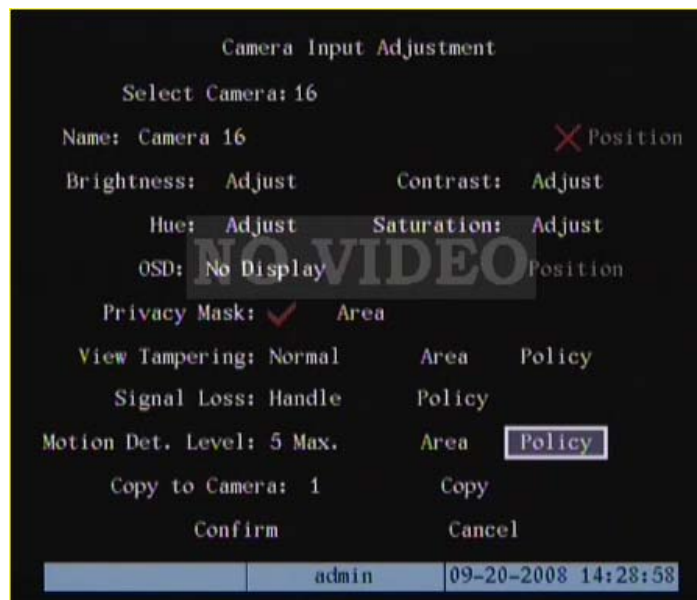

Step 2: Select camera: Use[↑][↓]key to select one camera.

Step 3: Select motion detection sensitivity: On the right side of “Motion Det. Level” item, there is a list box. That is motion detection sensitivity. There are 7 options, from 0 (the lowest) to 5 (the highest) and “Off”. You can use[↑][↓]keys to select one. If you select “Off” option, DVR will not response even if there is motion detection. If you select other options, it will active “Motion Area Setup” button and “Policy Setup” button. If you select low sensitivity such as 0, only when there are great motion detection, DVR can response. On the other side, for high sensitivity such as 5, DVR will response with small motion detection.

Step 4: Motion area setup: You must define motion areas so that DVR will response when there is motion in those areas. Move “Active Frame” to “Area” button on the right side of sensitivity list box, press[ENTER]key, you can enter “Motion Area Setup” interface.

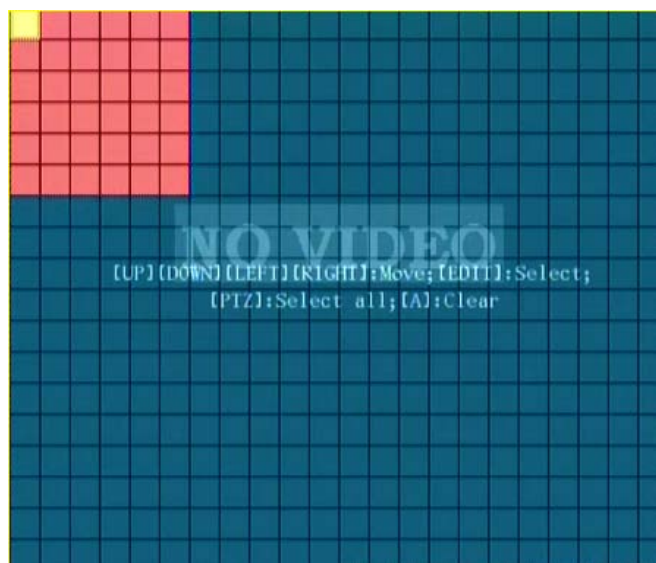

The whole screen is divided into 22*18 panes (NTSC: 22*15). There is one yellow panel on the upper left side. The motion area setup steps are the same as that of mask area setup (refer to chapter 5.7). The only differences are that you can use[PTZ]key to set the whole screen as motion area, and mutil motion areas can be defined. **Press[A]key to clear all motion areas.**

Setup multi areas: After you setup one motion area, press[EDIT]key, the yellow pane will appear again, then you can setup another motion area.

Clear motion area:

Clear part of motion area: Move the yellow pane to the start clear position of motion area, press[EDIT], you will find the yellow pane is turned into black pane. You can use[↓][→]key to enlarge or shrink the black area. Press[EDIT]key to clear this part motion area.

Press[Enter]key to save and return “Image” menu. Press[ESC]to cancel.

Clear all motion areas: Press[A]key to clear all motion areas of this channel.

The kyes used to setup motion areas are following:

- [↑][↓][←][→]: Move yellow panel to any position;
- [EDIT]: Yellow panel and red panel switch key;;
- [→]: Right enlarge red pane;
- [←]: Left shrink red pane;
- [↓]: Down enlarge red pane;
- [↑]: Up shrink red pane;
- [PTZ]: Set whole screen as motion area;
- [A]: Clear all motion areas;
- [ENTER]: Save and return “Image Setup” menu;
- [ESC]: Cancel setup and return “Image Setup” menu;

The motion detection area is displayed as follows:

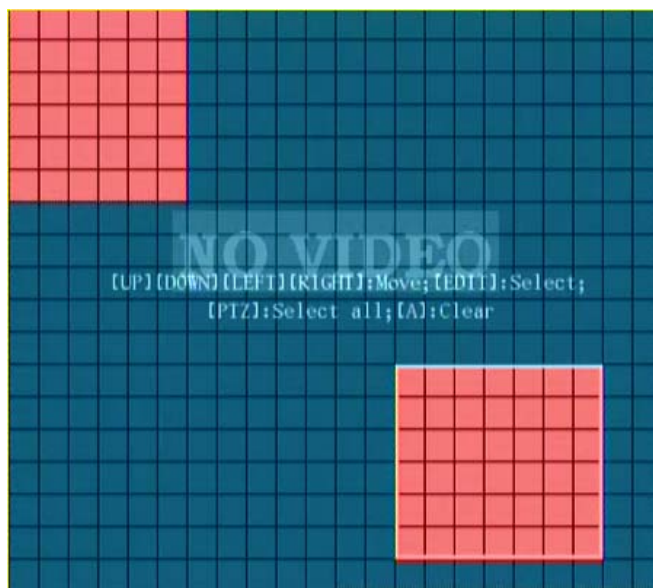

Step 5: Motion alarm policy: Move “Active Frame” to the corresponding “Policy” button of motion detection alarm, press[ENTER]key to enter “Motion Alarm Handle” menu:

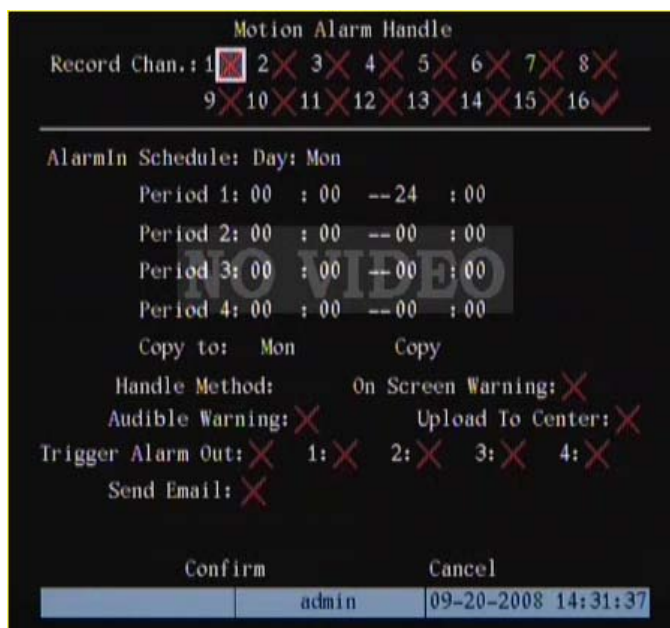

Step 6: Motion alarm record channel setup: When there is motion alarm happened, you can trigger related camera to start recording. In “Motion Alarm Handle” menu, you can select one or more record channels. Please use[ENTER]or[EDIT]key to enable the flag into “✓”.

Note: In order to make the cameras start recording, in “Recording” menu, you must enable recording schedule and set “Rec Type” as “Motion Detection” or “Motion | Alarm”. Please refer to chapter 5.12 for recording setup.

Step 7: Motion alarm schedule: When the motion alarm is happened in schedule, DVR will

response such as “On Screen Warning”, “Audible Warning”, “Upload to Center”, “Trigger Alarm Output” and “Send Email”. You can setup 4 time periods for one day and 7 days for one week.

Note: Time periods in one day can not be repeated.

Step 8: Motion alarm handle method setup: You can select one or more handle methods such as “On Screen Warning”, “Audible Warning”, “Upload to Center”, “Trigger Alarm Output” and “Send Email”.

Description: If “On Screen Warning” is enabled, when there is motion alarm happened and DVR is in preview mode, DVR will pop-up the related camera. If you trigger more than one camera, DVR will pop-up them one by one every 10 seconds. When the motion alarm is disappeared, DVR will restore preview mode.

Step 9: Save motion alarm setup: Press “Confirm” button to return “Image Setup” menu. In the “Image Setup” menu, press “Confirm” button to save the current camera parameters.

Step 10: Save all cameras: You can repeat from step2 to step8 to setup motion detection parameters for other cameras. Also you can copy the parameters of one camera to any other cameras.

Note: Motion alarm area can not be copied.

If you want to disable motion alarm area and motion alarm policy, you just need to select the motion alarm sensitivity as “Off”.

5.11 Preview Properties

In “Preview” menu, you can setup preview mode, select out, screen switch time, enable or disable audio preview, alarm aux out and layout.

Step 1: Enter “Preview” menu: In the main menu, move “Active Frame” to “Preview” icon and press[ENTER], you can enter “preview” menu.

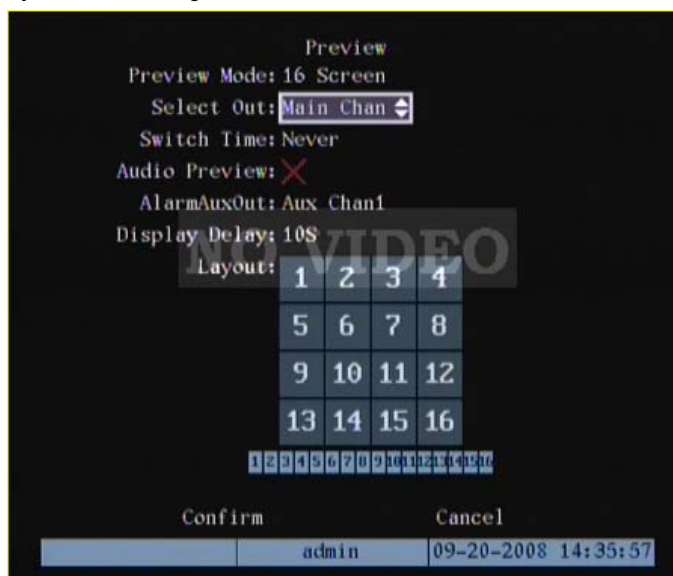

Step 2: Preview properties:

Preview mode: For preview mode item, you can use[↑][↓]key to select one mode. If DVR has only 1 channel, you can select only “1 Screen” option. If DVR has 4 channels, there are “1 Screen” and “4 Screen” options. If DVR has more than 4 but less than 9 channels, there are “1 Screen”, “4 Screen” and “9 Screen” options. If DVR has 16 channels, there are “1 Screen”, “4 Screen”, “9 Screen”, “12 Screen” and “16 Screen” options.

Select Out: Use “Select Out” to select the Main Chan or Aux Chan1 (i.e. Spot Out).

Switch time: That is image preview switch time. You can use[↑][↓]keys to select switch time. There are many options, including “5 Seconds”, “10 Seconds”, “20 Seconds”, “30 Seconds”, “1 Minutes”, “2 Minutes”, “5 Minutes” and “Nerver”. If you select “Nerver”, the preview image will not be switched automatically. For example, for 16 chanenls DVR, if you select “4 Screen” preview mode and “20 Seconds” switch time, DVR will cycle display 4 channels image every 20 seconds.

Audio preview: If you enable audio preview (“✓”), when you preview single camera, DVR will play the audio of that channel.

Alarm Aux Out: Switch to full alarming screen when there is an alarm signal.

Display delay: If you enable “On Screen Warning” option, when there are several cameras has alarm, DVR will popup the camer screen one by one according to this time interval

Preview layout setup: There is a square frame divided into many windows. If you select “4

Screen”preview mode, this frame is divided into 4 windows. Each window represents one camera. You can move “Active Frame” among the windows. There is one bar under the square to display the preview order of all cameras.

First select the biggest screen preview mode, for example, for 16-channel DVR, select “16 Screen” preview mode so that all windows are display in the square.

Secondly, move “Active Frame” to one of these windows, press numeric keys to input camera index (If DVR has less than 10 channels, just use one numeric key, otherwise, use 2 numeric keys). The small window will display that camera number. In this way you can change the display order. If you press 0 or 00, then the corresponding window will not display live video.

After you define the camera perview order, you can select preview mode to meet your demand.

Save setup: Press “Confirm” button to save preview properties. Press “Cancel” or [ESC]key to abort.

5.12 Recording Setup

In main menu, there is an icon named “Recording”. You can enter recording menu as follows:



“Recording” menu description:

If HD Full: There are two options: “Overwrite” and “Stop recording”. If you select “Overwrite” option, when all HDDs in DVR are full, DVR will overwrite the earliest recorded files and continue recording. If you select “Stop recording” option, when all HDDs are all full, DVR will handle it as “Hard Disk Full” exception, please refer to chapter 5.17 for exception menu.

SATA1 DISK: The first SATA harddisk can be used for normal recording or back-up, but since 7000HI-S can’t support external SATA, so we suggest you to select “record” item.

Select Camera: Here all channels are listed. You can use[↑][↓]keys to select one.

Record Parameters: There are two options: “Normal” and “Event”. When there is an event triggered, recording parameters will switch to event parameters automatically, after the events, recording parameters will switch back to normal parameters automatically. You can setup normal recording and event recording separately here.

Stream Type: There are two options, one is “Audio&Video” stream and the other is “Video” stream only. If you want to record video and audio, please select “Audio&Video” option, otherwise you can select “Video” option to record only video. For DS-7008HI-S DVR, there is only one “Video” option.

Note: If you change this option, please reboot DVR to make parameter into effective.

Resolution: The higher resolution is, the clearer the image is. The resolution options from low to high are: QCIF, CIF, 2CIF, DCIF, 4CIF.

DS-7004HI-S: Each channel supports 4CIF@8FPS, DCIF@8FPS, 2CIF@15FPS, CIF/QCIF@real-time.

DS-7008HI-S/DS-7016HI-S: Each channel supports 2CIF@15FPS, CIF/QCIF@real-time.

Note: If you change this resolution option, please reboot DVR to make it become effective.

Bit Rate Type: There are two options: “Variable” and “Fixed”.

If you select variable bit rate, DVR will adjust the actual bit rate according to the video movement. When there is not much movement, DVR will use low bit rate, while there is much movement, DVR will use high bit rate. In this case, DVR can save HDD usage and network bandwidth.

If you select fixed bit rate, DVR will use the fixed bit rate to compress iamge. The bit rate size is defined in “Max Bit Rate” option. In this case, we can calculate the recorded file size and network bandwidth that we need.

Max Bit Rate: If you select variable bit rate, when the video input has great movement, we need to limit the max bit rate. The max bit rate has follows options (bps): 32K, 48K, 64K, 80K, 96K, 128K, 160K, 192K, 224K, 256K, 320K, 384K, 448K, 512K, 640K, 768K, 896K, 1M, 1.25M, 1.5M, 1.75M, 2M and “User define”.

The max bit rate selection has relations with resolution. If you select high resolution, you must select high bit rate. For CIF resolution, the typical max bit rate is 384K-768Kbps. For DCIF resolution, the typical bit rate is 512K-1Mbps. For 4CIF resolution, the typical bit rate is 1Mbps~1.5Mbps. Of course, you will select the proper max bit rate based on the camera, background and image quality requirement.

Bit rate: You can select bit rate size for fixed bit rate type. It is the same as “Max Bit Rate”.

Image Quality: If you select variable bit rate type, you can define image quality. There are 6 options: Highest, Higher, High, Average, Low and Lowest. High image quality needs high bit rate size.

Frame Rate: Frame per second. Options are: Full (PAL is 25 FPS and NTSC is 30FPS), 20, 16, 12, 10, 8, 6, 4, 2, 1, 1/2, 1/4, 1/8, 1/16. For low frame rate, you can select low bit rate size.

Enable Event Para: The setting activates Event recording parameters. “×” means disable and “✓” means enable the function.

Enable Rec: The setting decides whether the camera will start recording. Recording may be halted according to the additional schedule settings.

Schedule: When you enable recording function, you can setup recording schedule.

PreRecord Time: When you enable motion detection recording or external alarm recording, you can define prerecord time. The options are: No PreRecord, 5 Seconds (default selection), 10 Seconds, 15 Seconds, 20 Seconds, 25 Seconds, 30 Seconds and Max PreRecord.

MaxPreRecord is to save all data in PreRecord buffer. The PreRecord time is related with bit rate. The lower bit rate, the longer PreRecord time is.

If the bit rate (Max bit rate) is very low, and you select “PreRecord Time” as “5 Seconds”, maybe the actual perrecord time is more than 5 seconds. On the other side, if the bit rate is high, and set “PreRecord Time” as “30 Seconds”, the actual prerecord time maybe is less than 30 seconds.

PostRecord Time: When external alarm or motion alarm is stopped, DVR will continue recording time. The options are: 5 Seconds (default), 10 Seconds, 30 Seconds, 1 Minute, 2 Minutes, 5 Minutes and 10 Minutes.

Enable Rec: Enable or disable selected camera record function. “x” means disable and “✓” means enable.

Schedule: When you enable recording function, you can setup recording schedule.

Note: When the camera’s recording schedule is modified, you must reboot DVR to make it become effective.

All day recording setup:

Step 1: Enter recording schedule menu

In recording menu, use[ENTER]or[EDIT]key to enable record function (flag “✓”), press “Schedule” button to enter recording schedule menu.

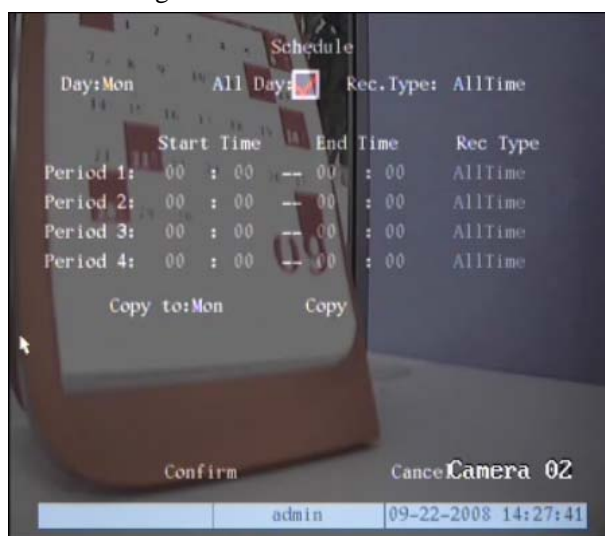

Step 2: Select on day and enable all day recording option

For “Day” item, there are options: Monday, Tuesday, Wednesday, Thursday, Friday, Saturday and Sunday. Use[↑][↓]keys to select one day. Move “Active Frame” to the check box on the right

side of “All Day” item, press[ENTER]or[EDIT]key to enable “All Day” option. “x” means disable and “✓” means enable.

Step 3: Record type

For “Rec Type” item, the options are: All Time, Motion Detect, Alarm, Motion|Alarm, and Motion&Alarm.

For all day record mode, only one record type can be selected.

Step 4: Copy to other days

You can repeat step2 and step3 to setup for other days. Also you can copy the current day to other days.

Step 5: Save

Press “Confirm” back to “Recording” menu. Press “Confirm” again to save the parameters and return main menu.

None all day recording setup

Step 1: Enter recording schedule menu

In recording menu, use[ENTER]or[EDIT]key to enable record function (“✓” flag), press “Schedule” button to enter recording schedule menu.

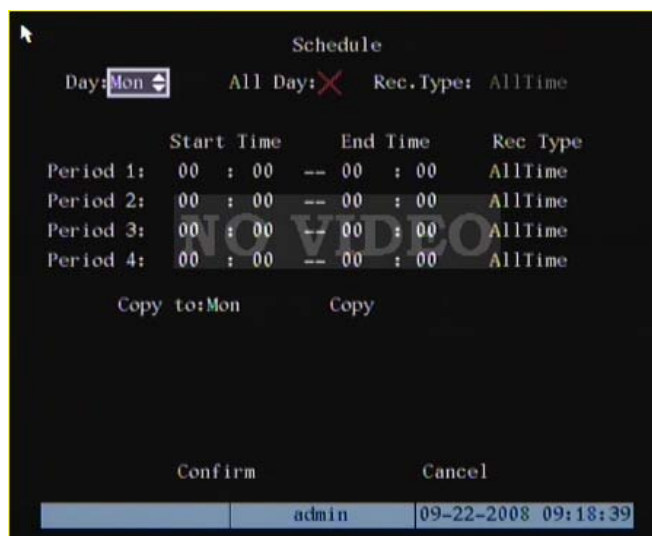

Step 2: Select on day and disable all day recording option

For “Day” item, there are options: Monday, Tuesday, Wednesday, Thursday, Friday, Saturday and Sunday. Use[↑][↓]keys to select one day. Move “Active Frame” to the check box on the right side of “All Day” item, press[ENTER]or[EDIT]key to disable “All Day” option. “x” means disable and “✓” means enable.

Step 3: Setup time period and record type

There are 4 time periods for one day, and each time period can select different record type.

Input start time and stop time for each time period, and select record type for each period. The record type options are: All Time, Motion Detect, Alarm, Motion&Alarm and Motion|Alarm.

Note: The time periods in one day can not be repeated.

Step 4: Copy to other days

You can repeat step2 and step3 to setup for other days. Also you can copy the current day to other days.

Step 5: Save

Press “Confirm” back to “Recording” menu. Press “Confirm” again to save the parameters and return main menu.

Note:

- 1) If record type is “Motion Detect” or other related types, you must setup “Motion Detection” in order to trigger motion recording (refer to chapter 5.10).
- 2) If record type is “Alarm” or other related types, you must setup “Alarms” in order to trigger alarm recording (refer to chapter 5.13).
- 3) The time period is among 00:00~24:00.

5.13 External Alarm Input and Relay Output

For 4-channel DVR, there are 4 external alarm input and 2 relay output. For 8-channel DVR, there are 8 external alarm input and 4 relay output. For 16-channel DVR, there are 16 external alarm input and 4 relay output. In “Alarms” menu, you can setup for each external alarm input.

In main menu, move “Active Frame” to “Alarms” icon and press[ENTER]key to enter alarms menu:

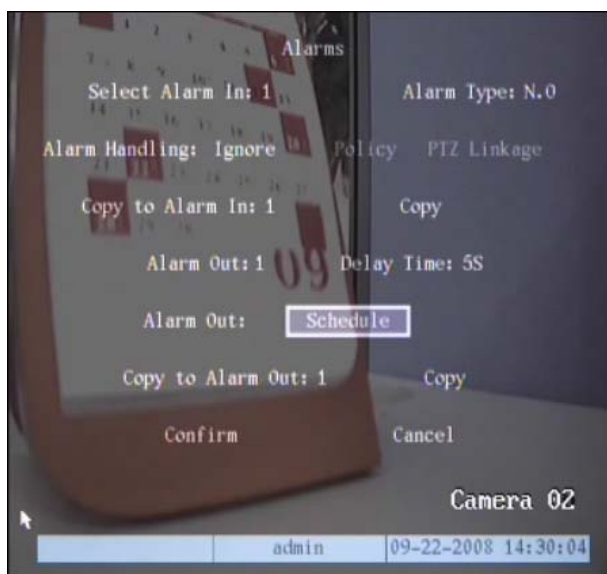

External alarm input setup:

Step 1: Select one alarm input

Use[↑][↓]keys to select one alarm input.

Step 2: Alarm type

This is sensor type. You can select “Normal Open” or “Normal Close” according to the sensor type.

Step 3: Enter “Alarm in Handling” sub menu

In the “Alarms” menu, there are two options for “Alarm Handling” item. One is “Ignore”, and the other is “Handle”. If you select “Handle” option, you can active “Policy” and “PTZ Linkage” buttons on right side. Move “Active Frame” to “Policy” button and press[ENTER]key, you will enter “Alarm in Handling” sub menu:

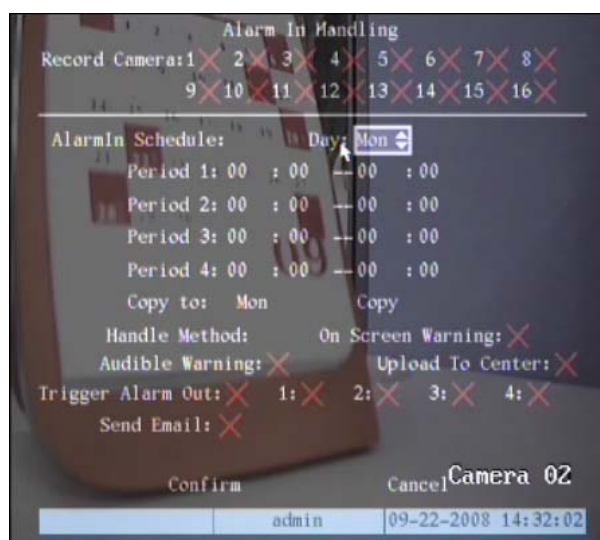

Step 4: Alarm trigger record channel setup

You can select channels to record for each alarm input. In the sub menu, you can use [ENTER] or [EDIT] key to enable record channel. “x” means disable and “✓” means enable.

Note: In order to trigger the channel to record, in “Recording” menu, you must enable recording and select record type as “Alarm” or other related type. Please refer to chapter 5.12.

Step 5: Schedule for alarm handle method

When there is external alarm happened in the schedule, DVR will response according to the handle methods.

Step 6: Alarm handle method

You can select one or more handle method: “On Screen Warning”, “Audible Warning”, “Upload to Center”, “Trigger Alarm Output” and “Send Email”.

Description: If “On Screen Warning” is enabled, when there is external alarm happened and DVR is in preview mode, DVR will pop-up the related camera. If you trigger more than one camera, DVR will pop-up them one by one every 10 seconds. When the external alarm is disappeared, DVR will restore preview mode.

Step 7: Save setup

In “Alarm in Handling” sub menu, press “Confirm” button and return “Alarms” menu. In “Alarms” menu, press “Confirm” button to save the parameters.

Step 8: PTZ Linkage

Move “Active Frame” to “PTZ Linkage” button, press [ENTER] key to enter “PTZ Linkage” setup menu:

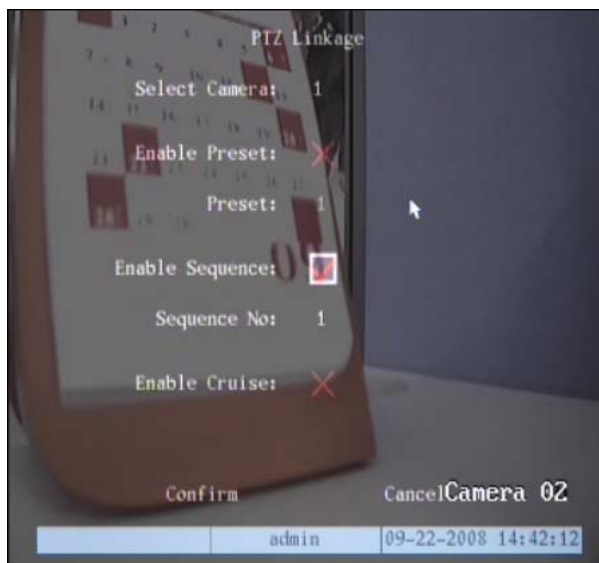

First select one camera, and then select one of following PTZ linkage:

- Preset: Set the flag as “✓” to enable preset, in the preset number edit box and input one preset number that has been setup already. Please refer to chapter 5.15 for preset setup.
- Sequence: Set the flag as “✓” to enable sequence and input one sequence number that has been setup already. Please refer to chapter 5.15 for sequence setup.
- Cruise: Set the flag as “✓” to enable cruise. Please refer to chapter 5.15 for cruise setup.

Press “Confirm” button to save and return “Alarms” menu. Press “Cancel” button or [ESC]key to abort and return “Alarms” menu.

Note: Please make sure that the PTZ you are using can support preset, sequence and cruise functions. One external alarm input can trigger many cameras PTZ linkage.

Step 9: Copy the parameters to other external alarm input

You can copy the parameters of current alarm input to other external input.

Step 10: Save setup

In “Alarms” menu, press “Confirm” button to save the parameters. Press “Cancel” button or [ESC]key to abort.

Alarm relay output setup

Step 1: In “Alarms” menu, use [↑][↓]keys to select one alarm output.

Step 2: Select delay time

The delay time is when the alarm disappeared; the alarm output will continue output time. The delay time options are: 5 Seconds, 10 Seconds, 30 Seconds, 1 Minute, 2 Minutes, 5 Minutes, 10 Minutes and Manual Stop. If you select “Manual” option, the alarm output will not stop until you press “Clear Alarm” button in “Utilities” menu. So the actual alarm output time is made up of alarm input time and this delay time.

Step 3: Enter alarm out schedule

You can set the schedule to make alarm output into effective. Move “Active Frame” to “Schedule” button on right side of “Alarm Out Time” item, press [ENTER] key to enter the corresponding schedule menu:

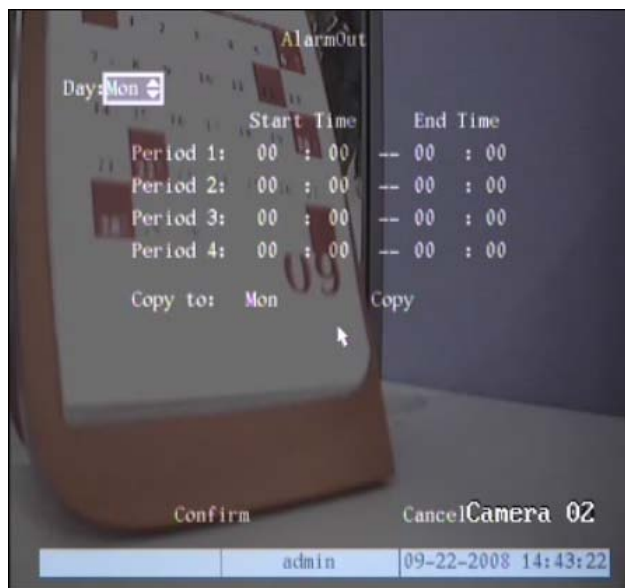
**Step 4: Setup alarm out schedule**

Like other schedule setup, you can set 4 time periods for one day and 7 days for one week. When you finish setup, press “Confirm” button to return “Alarms” menu.

Step 5: Copy one alarm output parameters to other alarm output

In “Alarms” menu, you can copy parameters of current alarm output to other alarm output.

Step 6: Save setup

When you finish setup, in “Alarms” menu, press “Confirm” button to save all parameters.

Note: If any schedule is modified, you must reboot DVR to make it become effective.

5.14 Network Parameters

If you want to use network to access DVR, you must setup network parameters.

Note: If any of the network parameters is modified, you must save and reboot DVR to make it become effective.

In main menu, move “Active Frame” to “Network” icon and press[ENTER], you can enter “Network” menu as follows:

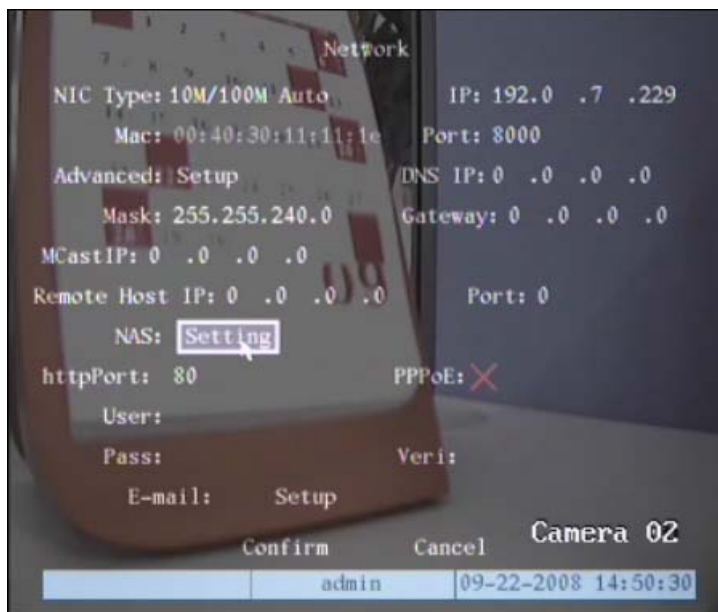

“Network” menu description:

***NIC type:** Default is “10M/100M Auto”, the other options are: 10M Half-Dup, 10M Full-Dup, 100M Half-Dup and 100M Full-Dup.

***IP address:** This IP address must not be conflict with other IP. If there is DHCP server in network, you can set the IP as “0.0.0.0”, save and reboot DVR. In reboot process, DVR will search the DHCP server and get one dynamic IP address. This item will display the dynamic IP address. If DVR uses PPPoE function, also DVR can dialup into internet and this item will display the dynamic internet IP address.

***Port:** Network access port number, must be greater than 2000.

***Advanced setup:** NTP is used for synchronizing time with time server, time server is provided by NTP service provider: time.windows.com which is a famous time server provided by Microsoft.

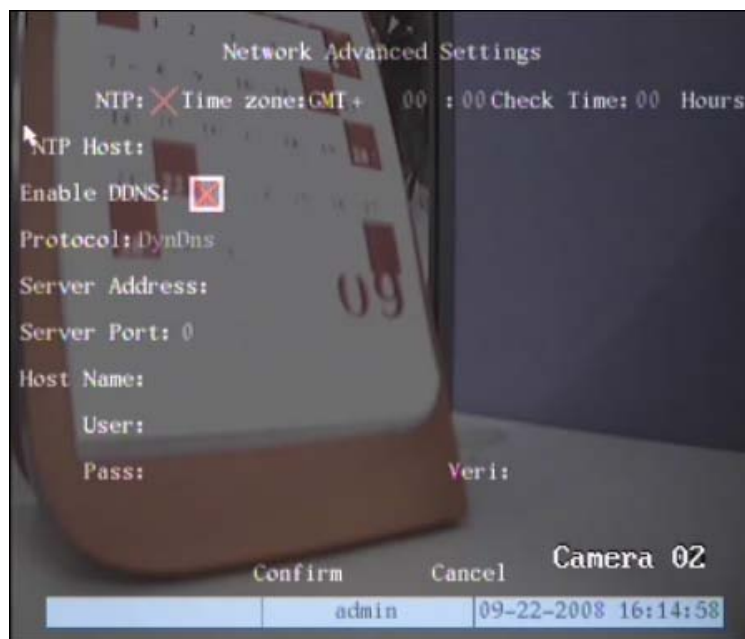

NTP Host: NTP server name.

DDNS: Currently supports two protocols provided by DDNS service supplier. www.dyndns.com or www.peanuthull.com.

Protocol: Three options including DynDns, PeanutHull or IP Server.

Server address: The DDNS server provided by DDNS service supplier

Server Port: Provided by the supplier.

Host name: The domain name register by yourself on the web site of dyndns or peanuthull

User name and password: The user name and password of your DDNS account, get from DDNS service supplier.

***DNS IP:** If the DVR uses the PPPoE function, and get one dynamic IP address. If you set IP server with one fixed Internet IP, DVR will send some information such as DVR name, DVR serial number, DVR current IP to that fixed IP address. We call that fixed Internet IP as IP server. The IP server with that fixed Internet IP can receive DVR information and used to resolve DVR dynamic IP. "IP server" is special software. You can use the provided SDK to develop this IP server software.

***Mask:** This is the sub net mask.

***Gateway:** The gateway IP is used to communicate in different network segments

***Multicast IP:** It is one D-class IP address, among 224.0.0.0 --- 239.255.255.255. If you do not use multicast function, you do not need to set. Some routers will prohibit multicast function in case of network storm.

***Remote Host IP and Port:** If you set this IP and port, when there is alarm and exception happened, DVR will send information to that host IP. The center with this IP can receive alarm and exception information from DVR. You can use SDK to develop this center software.

***NAS:** Network access storage. DVR will regard network HDD as local HDD. If you enable this function by select “NAS setting”, DVR will send and save the real time image to that network HDD.

Index IP: The IP of that network storage server.

Directory: The directory name shared by that network storage server.

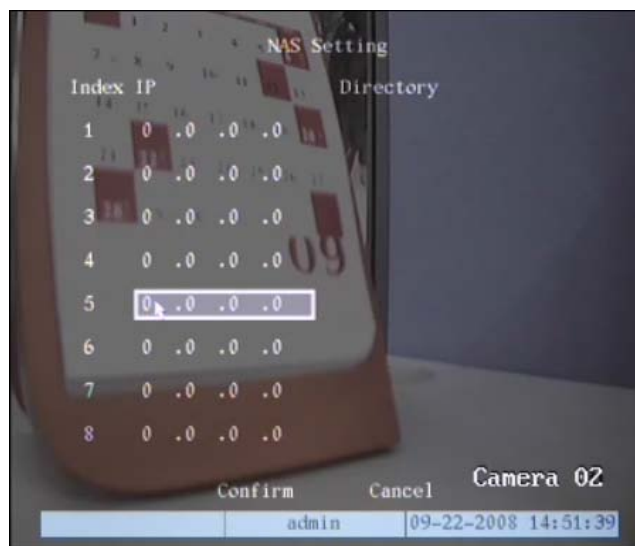

***HttpPort:** The port is for IE browser. The default value is 80. It can be modified.

***PPPoE:** DVR supports PPPoE dail-up function.

Example: Use PPPoE function

Step 1: Enter “Network” menu.

Step 2: Select NIC type.

Step 3: Input port number. In the port edit box, use numeric keys to input port number. The port number must be more than 2000.

Step 4: Input DNS IP. Input one fixed Internet IP address where the IP analyst software (IPServer) is run.

Step 5: Input PPPoE parameters. Use[ENTER]or[EDIT]key to enable PPPoE function (set PPPoE flag as “√”). Input PPPoE username, password and verify password that ISP provided.

Step 6: Save parameters. In “Network” menu, press “Confirm” to save parameters. Reboot DVR to make parameters into effect. In reboot process, DVR will start dialup using PPPoE function. If DVR dialup Internet successfully, DVR will display the dynamic internet IP address in “Network” menu.

***Email:** This function enables image capture and sending emails to designated e-mail address (max 2 e-mail addresses at the same time) when abnormality occurred.

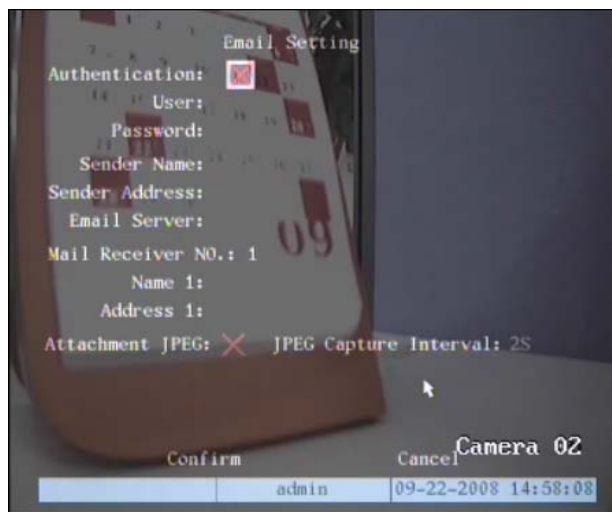

You can also modify email parameters as follows:

Authentication: If your Email server asks for a user name and password when sending Email, you need to tick this check box

User: Email account user name

Password: Email account password

Sender Name: Name appears in Email

Sender Address: Sender Email address

Email server: SMPT supported Email sending server

Mail receiver name: The name appears in Email

Mail receiver address: Receiver Email address

Attachment JPEG: Sending the Email with JPEG picture capture when abnormality occurred.

5.15 PTZ

There is one RS-485 port at DVR rear panel that used for PTZ control. You can setup RS-485 parameters to match your PTZ protocol. In main menu, move "Active Frame" to PTZ icon and press[ENTER]key, you can enter PTZ menu as follows:

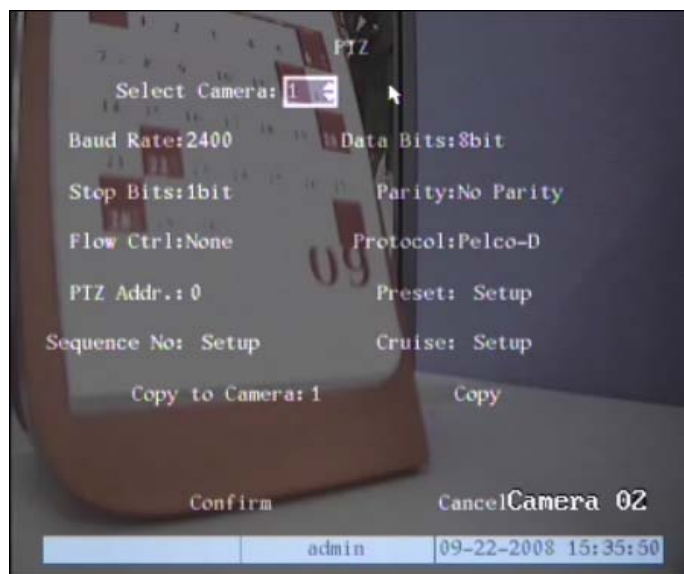

PTZ menu description

Select channel: Select one PTZ camera.

RS-485 parameters: Including baudrate, data bit, stop bit, parity, flow control, etc. These parameters must be the same as those PTZ Protocols.

PTZ address: Each PTZ has one different address.

PTZ type: DVR had the following PTZ protocol: YouLi, LinLin-1016, LinLin-820, Pelco-p, DM DynaColor, HD600, JC-4116, Pelco-d WX, Pelco-D, VCOM VC-2000, NetStreamer, SAE/YAAN, Samsung, Kalatel-312, CELOTEX, TLPelco-p, TLHHX-2000, BBV, RM110, KC3360S, ACES, ALSON, INV3609HD, Howell, Tc Pelco P, Tc Pelco D, AUTO-M, AUTO-H, ANTEN, CHANGLIN, DeltaDome, XYM-12, ADR8060, EVI-D30, DEMO-SPEED, DM-PELCO-D, ST832, LC-D2104, HUNTER, A01, TECHYIN, WEIHAN, LG, D-MAX, Panasonic, KTD-348, infinova, PIH-7625, LCU, DennaDome, etc. Other PTZ protocols will be added with the new firmware.

Note: In DVR "PTZ" menu, if you select Pelco-P protocol, when you setup PTZ address, please plus or minus one compared with Camera ID. For example, if camera ID is 2, the DVR PTZ address is set as ID 3.

Preset setup: Preset is using one number to represent the camera's position, zoom, focus and iris. Move "Active Frame" to "Setup" button on the right side of "Preset" item, press[ENTER]key to enter preset setup menu. You can save 128 preset numbers. Please make sure the PTZ supports preset function before you setup preset.

Sequence setup: Each sequence is made up of several curise points. Each curise point includes one preset number, dwell time and dwell speed. Please make sure the PTZ you are using can support sequence function before you start to setup. You can save 16 sequeence.

Cruise setup: Cruise is remembering the track of PTZ movement. Please make sure the PTZ you are using can support cruise function.

Preset setup

In “PTZ” menu, move “Active Frame” to “Setup” button on the right side of “Preset” item, press[ENTER], you can enter “Preset” setup menu:

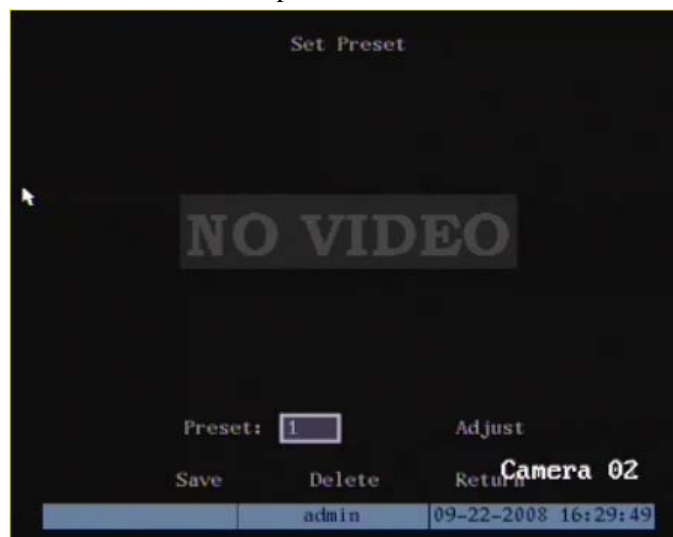

Add preset number: You can input preset number (among 1-128) in the edit box. Then press “Adjust” button to enter PTZ control interface. In PTZ control interface, you can use direction keys to adjust PTZ position, and use[IRIS+] [IRIS-] [FOCUS+] [FOCUS-] [ZOOM+][ZOOM-]keys to adjust iris, focus and zoom. After you finish adjusting, press[ENTER], then press “Save” button to save the preset number. You can repeat this step to setup other preset numbers.

After you setup all preset numbers, press “Return” button to return “PTZ” menu. In “PTZ” menu, press “Confirm” button to save all parameters.

Delete preset number: In “Preset” setup menu, input one preset number, press “Delete” button, you can delete this preset number.

After deleting, press “Return” button to “PTZ” menu. In “PTZ” menu, press “Confirm” button to save all modification.

Please make sure the PTZ you are using can support preset function.

Sequence setup

In “PTZ” menu, press “Setup” button on the right side of “Sequence No” item, you can enter “Sequence” setup menu:

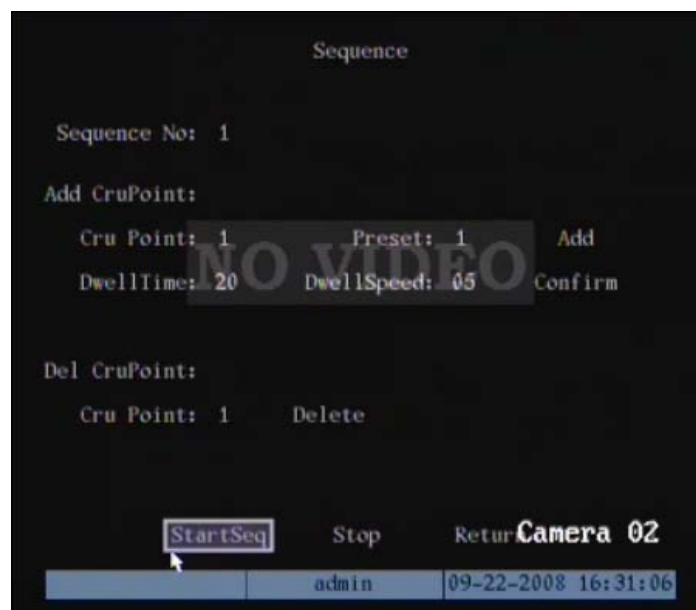

In “Sequence” setup menu, first input the sequence number. The sequence is among 1 --- 16. Each sequence is made up of cruise points, and each cruise point includes preset number, dwell time and dwell speed. Dwell time is the time staying at that preset number. Dwell speed is the speed that PTZ is moved to that preset number.

Press “Add” button to add one cruise point.

Press “Confirm” button to save the cruise point into the sequence.

After you finish setup the sequence number, press “StartSeq” to check the current sequence. Press “StopSeq” button to stop checking.

You can delete cruise points in one sequence.

After you finish sequence setup, press “Return” button back to “PTZ” menu. In “PTZ” menu, press “Confirm” button to save the modification.

Please make sure the PTZ you are using can support sequence function.

Cruise setup

In “PTZ” menu, press “Setup” button on the right side of “Cruise” item, you can enter “Cruise” setup menu:

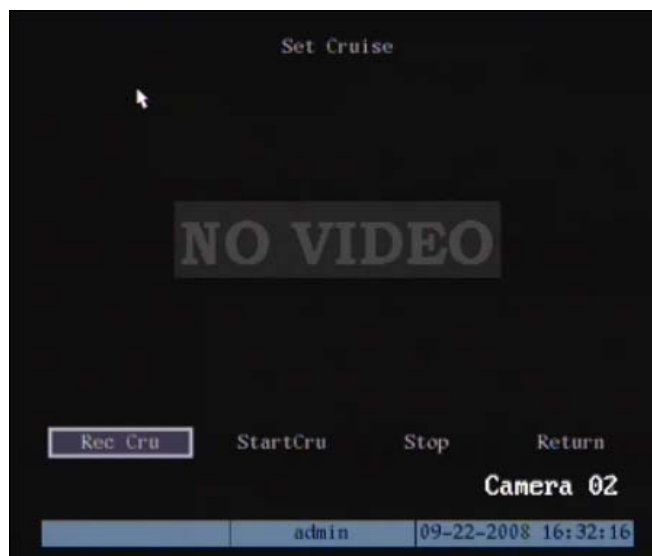

Press "RecCru" button, you will enter "PTZ control" interface. You can start controlling PTZ with direction keys, press[ENTER]to save the operation track and return "Cruise" setup menu. Press "StartCru" button to repeat the PTZ track until you press "Stop" button.

Press "Return" button back to "PTZ" menu. In "PTZ" menu, press "Confirm" button to save this cruise.

Please make sure the PTZ you are using can support cruise function.

5.16 RS232 setup

There is one RS-232 port at DVR rear panel. In main menu, move “Active Frame” to “RS232” icon and press [ENTER] key, you enter “RS232” setup menu:

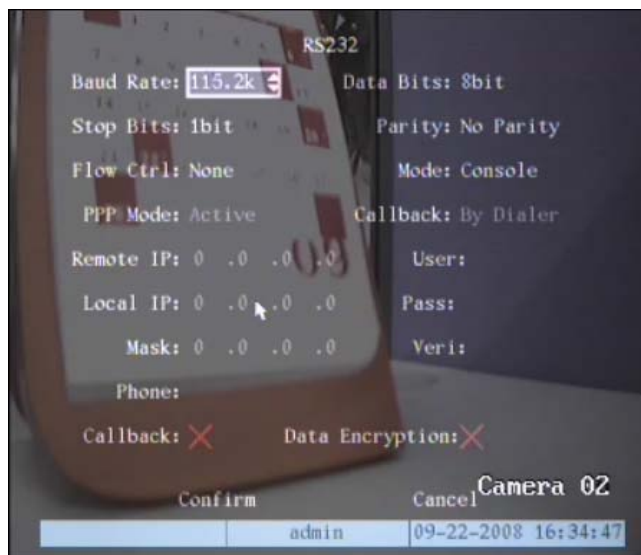

RS232 menu description

RS-232 parameters: Including baud rate, data bit, stop bit, parity, flow control, etc.

Work mode: The RS-232 can be used as “Console”, “PPP” or “Transparent Channel”.

Console: Connect with PC serial port. You can use HyperTerminal or NetTerm to control it.

PPP: Connect Modem, using PSTN to transfer video image.

Transparent channel: Connect serial devices. Remote PC can control these serial devices through network.

PPP Mode: Only used when work mode is “PPP”. There are two options: “Active” and “Passive”. “Active” means DVR will dialup through PSTN. “Active” function is not available. “Passive” means DVR will wait for dialup.

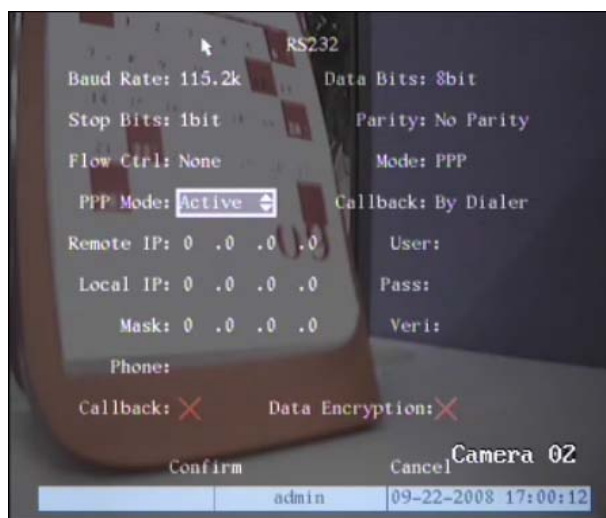

Callback mode: Only used when work mode is “PPP”. There are two options: “By Dialer” and “Preset Tel”. This function is not available.

Remote IP: Only used when work mode is “PPP”. This IP is defined for remote PC that will connect DVR through PSTN.

Local IP: Only used when work mode is “PPP”. This IP is defined for DVR.

Mask: Only used when work mode is “PPP”. Remote IP and Local IP are in the same sub net.

Username, password and Verify password: Only used when work mode is “PPP”. Used for login when remote PC dialup through PSTN.

Phone: Only used when work mode is “PPP” and PPP mode is “Active”. It is the phone number of remote PC.

Callback and Data Encryption: Only used when work mode is “PPP”. They are not available.

Confirm: Save parameters and return to main menu.

Cancel: Abort modification and return main menu.

Example: PPP (Modem) passive dialup through PSTN

There are two Modems. One is connected DVR RS-232 port with DCE cable. The other is connected with PC COM port.

Setup at DVR end

Step 1: RS232 setup Setup baud rate, data bit, stop bit, parity and flow control. They must be the same as those of modem connected with PC.

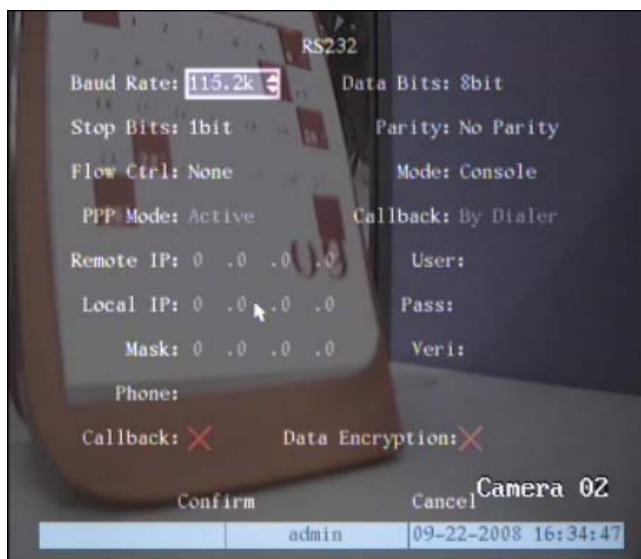

Step 2: Video setup In “Recording” menu, select the camera you want to transfer through PSTN. If you set CIF resolution, we suggest you set frame rate as 1 FPS. If you set QCIF resolution, the frame rate can be selected under 4FPS. You can adjust bit rate, resolution and frame rate according to real conditions.

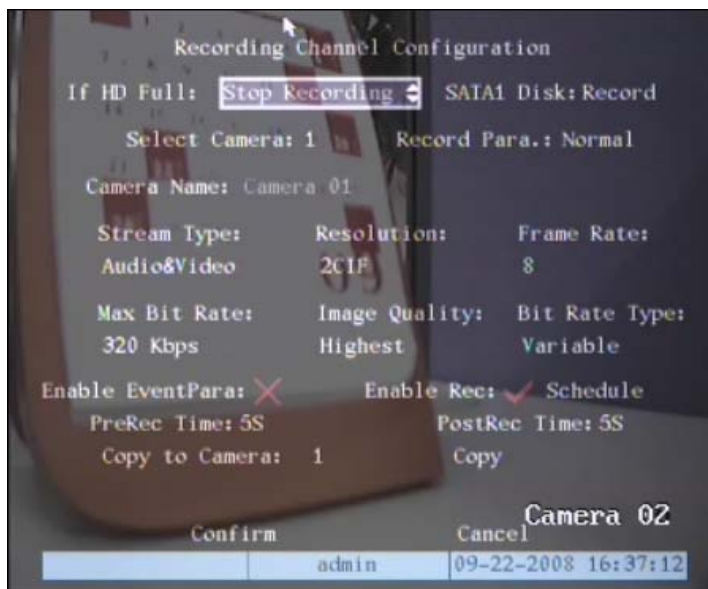

Step 3: Save setup In “Recording” menu, press “Confirm” button to save parameters.

Step 4: Setup Modem used on DVR side Use DCE cable to connect Modem with PC serial port. You can use HyperTerminal or NetTerm to setup modem:

AT&F ---- Restore default parameters (Generally, Modem is hard flow control)

AT&S0=1 ---- Set Modem as answer

ATE0 ---- Not display the input characters

ATQ1 ---- Commit instruction and not display

AT&W&W1 ---- Save parameters

Step 5: Use DCE cable to connect Modem with DVR RS232 port.

Setup at PC end

Step 1: Setup Modem used on PC side. Use DCE calbe to connect Modem with PC serial port. You can use HyperTerminal or NetTerm to setup modem:

AT&F ---- Retore default parameters (Generally, Modem is hard flow control)

AT&W&W1 ---- Save parameters

Step 2: Open “Network and Dial-up Connections” in control panel, then press “New Connection...”, select “Dial-up to private network” according to the guide. Select the corresponding MODEM input the telephone no. to be dialed in the next step, finish it according to the guide. At this time, you will find a new program named “Dial-up Connection” in “Network and Dial-up Connections” folder.

Setup should be specially pay attention to:

Open the properties of the new-established dialup program, select “Advanced”(custom settings) in security option, press setup, set it in the popup dialogue box that is “Advanced Security Settings” as follows:

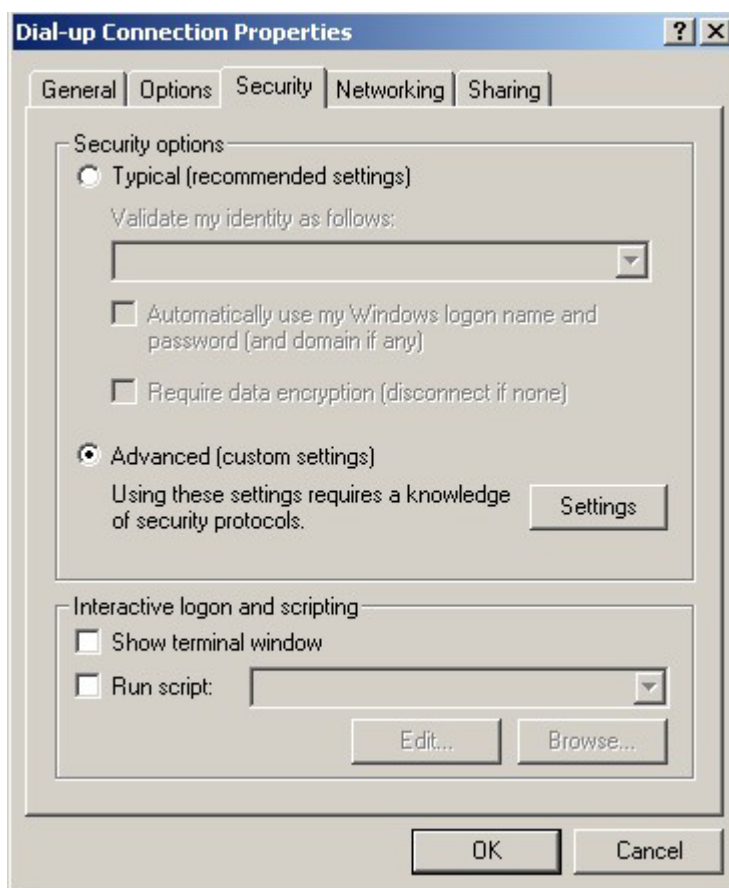

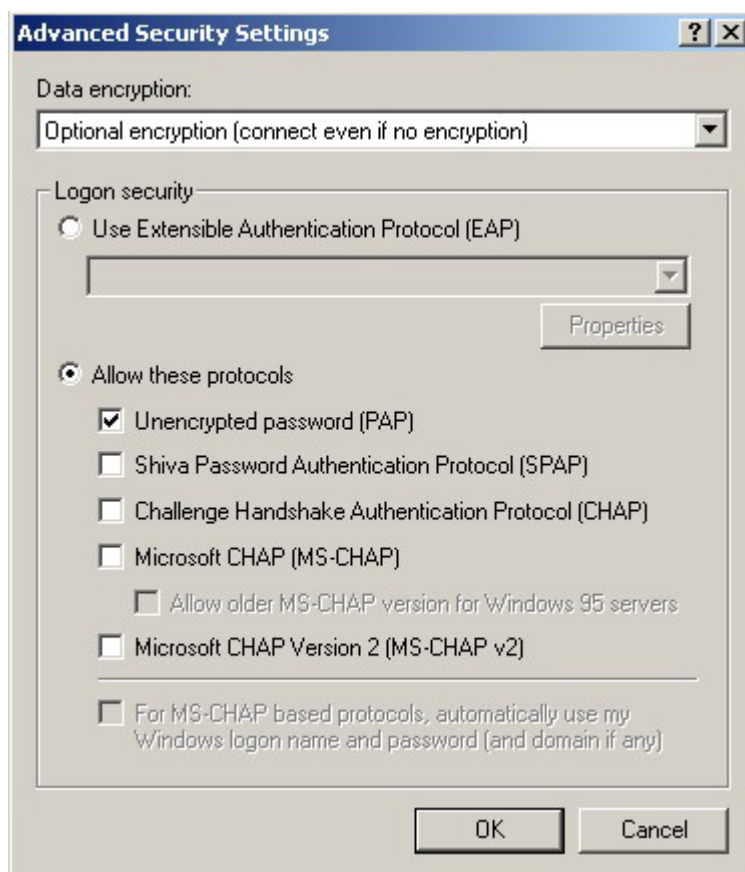
**Step 3: Establish the dialup connection**

Select the Modem connected with PC just like the dialup network connection, input the telephone number connected with DVR's modem. Input the username, password. They must be the same as that DVR PPP setup.

Step 4: During the dialup connection, it will give the message of "verification of username and password", after successfully verification; the message will be given "on process of register in PC". The process is the same as the common dialup connection.

Step 5: After successful dialup, network will designate the "remote IP" address to PC, e.g. the set 192.1.0.1. User can Ping-link the assigned IP address through Ping command, and can Ping-link DVR. Please refer to the following picture.

```
C:\>ipconfig

Windows 2000 IP Configuration

PPP adapter

    Connection-specific DNS Suffix  . :
    IP Address. . . . . : 192.1.0.1
    Subnet Mask . . . . . : 255.255.255.255
    Default Gateway . . . . . : 192.1.0.1

C:\>ping 192.1.0.2

Pinging 192.1.0.2 with 32 bytes of data:

Reply from 192.1.0.2: bytes=32 time=130ms TTL=64
Reply from 192.1.0.2: bytes=32 time=130ms TTL=64
Reply from 192.1.0.2: bytes=32 time=130ms TTL=64
Reply from 192.1.0.2: bytes=32 time=130ms TTL=64

Ping statistics for 192.1.0.2:
    Packets: Sent = 4, Received = 4, Lost = 0 (0% loss),
    Approximate round trip times in milli-seconds:
        Minimum = 130ms, Maximum = 130ms, Average = 130ms
```

Step 6: You can preview the image of 192.1.0.2 by using client-end software.

5.17 Exceptions

The exceptions can be handled at present include: hard disk full, hard disk error, illegal access, IP address conflict, network failure, and NTSC/PAL differ.

Enter “Exceptions” menu:

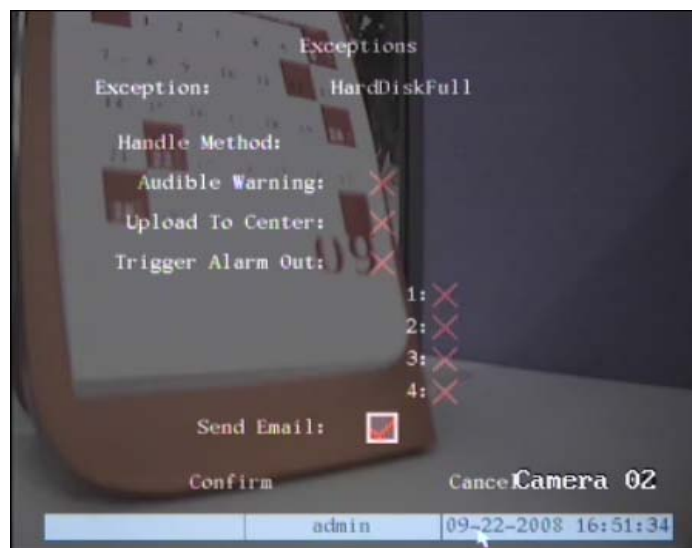

Including the following handle methods:

Audible Warning: DVR beep warning.

Upload to Center: Send exception information to center host PC.

Trigger Alarm Output: trigger local relay output.

Send Email: This function enables image capture when expectations triggered, and sending emails to designated e-mail address.

You can select more than one handle methods.

After you finish setup, press “Confirm” button to save parameters. Press “Cancel” button or [ESC] key to abort.

5.18 Transaction Information

The DVR can actively obtain or passively receive the credit card number from ATM machine linked through network or serial port, and credit card number can be overlay on live video, recorded and playback. The following description indicates how to carry out relevant parameter setting according to different links to ATM machine.

In “Transaction Information” menu, there are 4 kinds of text capture solutions:

1. Network Sniff: Obtain the transaction information such as credit card number actively through network.

The network connection is as follows:

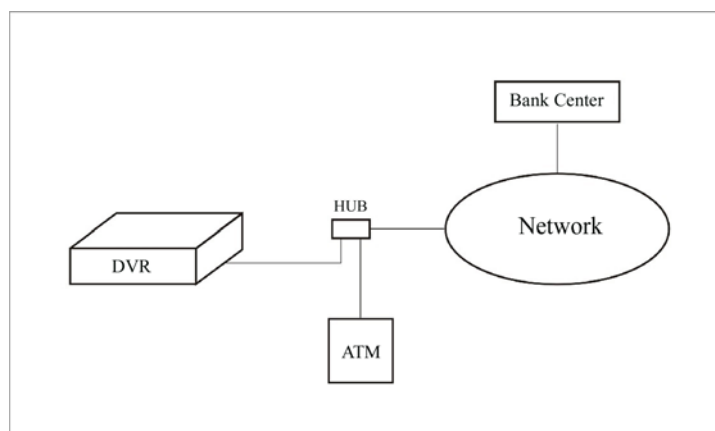

The corresponding setup menu is seen as follows:

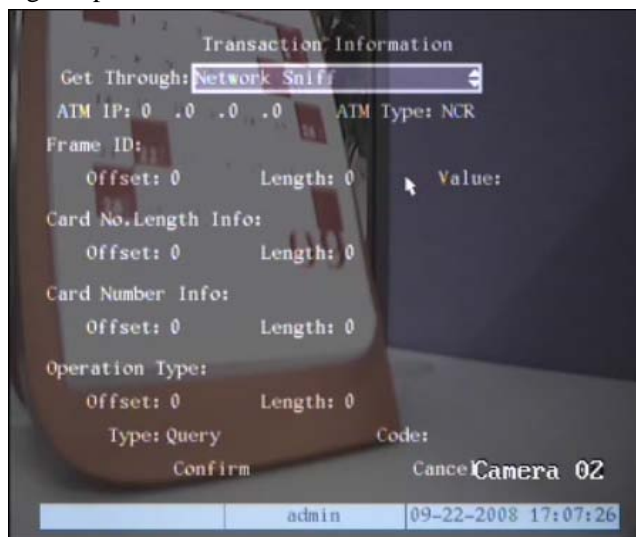

You need to setup the following information:

IP address of ATM machine

Type of ATM machine

Start & end position, length and the content of data message

Start & end position and length of credit card number

Start & end position and length of transaction type

Transaction type and code

When the ATM machine is sending transaction information to bank center, DVR will capture the data package through network, and analyse the data according to the format. Then DVR will overlay the correspond text on live video.

2. Network Receive: DVR receives data sent by ATM machine through network.

You only need to setup DVR listen port. The default port value is 10000.

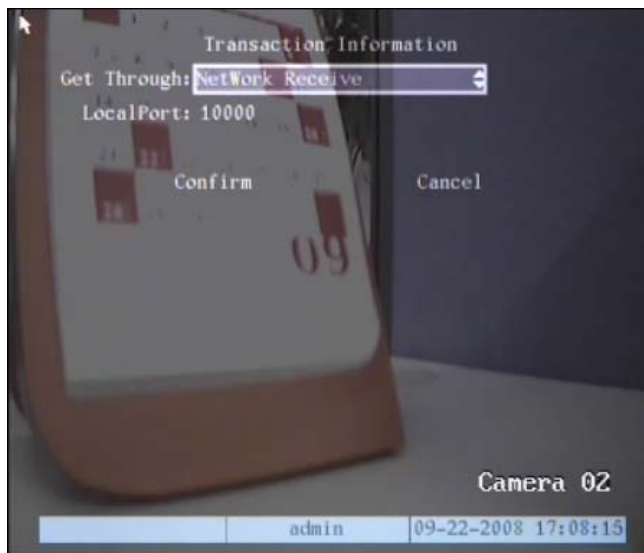

In this case, you must develop the software that is run in the ATM machine based on special protocol. The software will send the transaction information directly to the DVR. DVR will receive, analyse and overlay the text on live video.

2. Receive data sent by ATM through serial port

The connection is following:

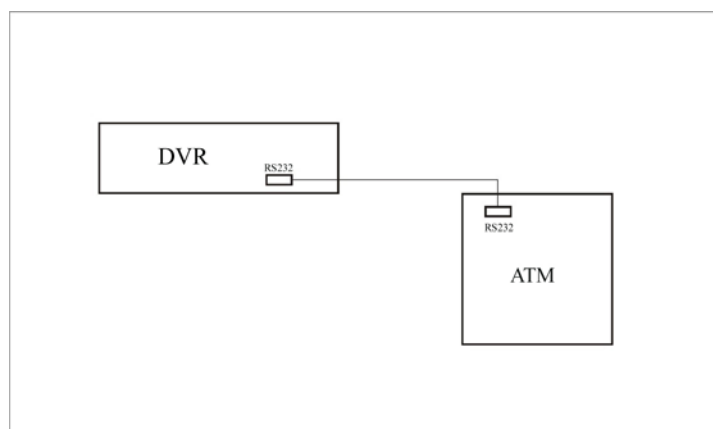

The corresponding setup menu is following:

You only need to setup ATM machine type.

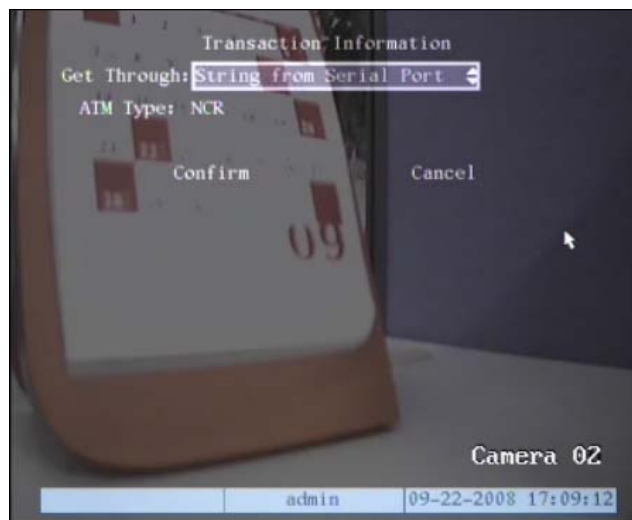

In this case, you must set the RS-232 of DVR as transparent channel mode as follows:

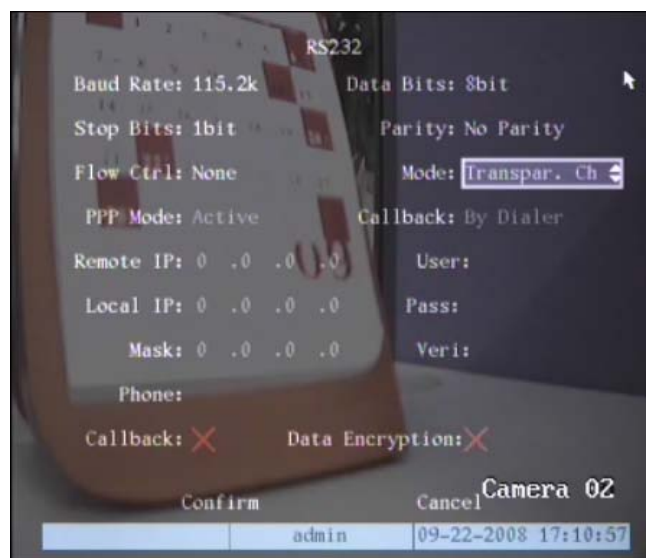

Software must be run in the ATM machine, and send the credit card number, transaction code to DVR through RS-232 port.

Please provide detail ATM machine communication protocol for actual projects.

3. Receive the command sent by ATM through serial port



In the case, you must set the RS-232 of DVR as transparent channel mode as follows:

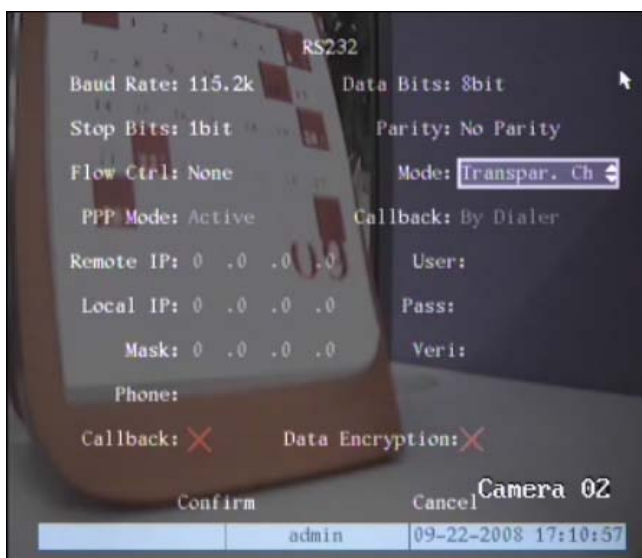

Also, software must be run in ATM machine, and send command to DVR through RS-232 port based on special communication protocol.

Chapter6 Utilities

There are many tools in “Utilities” menu, including “SavePara”, “RestorePara”, “Upgrade”, “Hard Disk”, “Stop Alarm Out”, “Reboot”, “Power Off”, “View Log” and “System Info”.

Enter “Utilities” menu:



6.1 Save Parameters

Save factory default parameters into FLASH memory. You can reboot DVR to make them become effective.

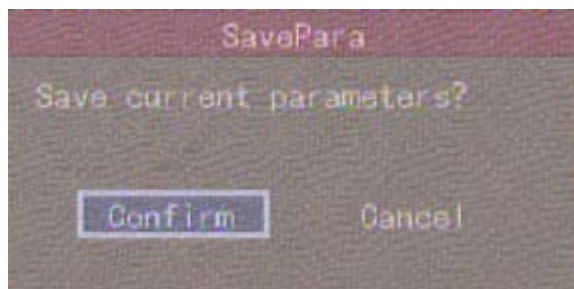

6.2 Restore Parameters

Restore factory parameters for DVR. The IP address, gateway and port number will not be restored.

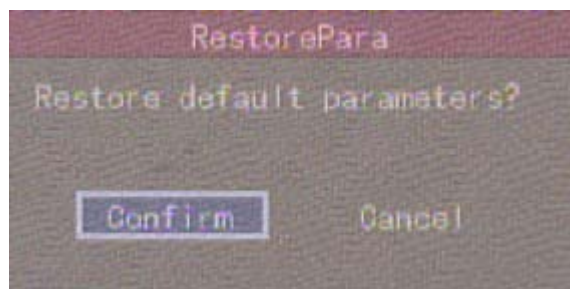

6.3 Upgrade

You can use this function to upgrade the firmware. Please confirm the language is matched.

Press “Upgrade” icon, in the pop-up dialog, you can select either “FTP” or “USB” upgrade mode.



If you select “FTP” mode, you will enter “FTP Upgrade” menu:

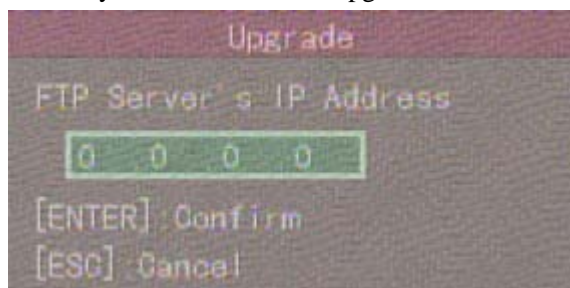

Input the ftp server IP and press[ENTER]key. DVR will connect with FTP server through network and download the firmware file.

If you select “USB” mode, please make sure you connect one USB flash memory with DVR and the firmware file is in its root directory.

You can also upgrade firmware from CD

Reboot after successfully upgrading, the system will use the new firmware.

6.4 Hard Disk Management



Check HDD work status

Capacity, Free space, Stand by or not, Normal status or not.

Format HDD

Before formatting stop all recording. After formatting, you must reboot DVR; otherwise DVR will not work normally.

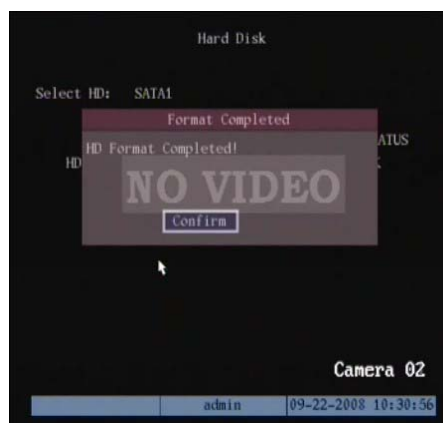

6.5 Clear Alarm Out

Clear the alarm output manually.

6.6 Reboot

Reboot DVR.

6.7 Power Off

Shut down DVR.

6.8 View Log

To view the log recorded in DVR HDD.

In “Utilities” menu, press “View Log” to enter “Log” menu:

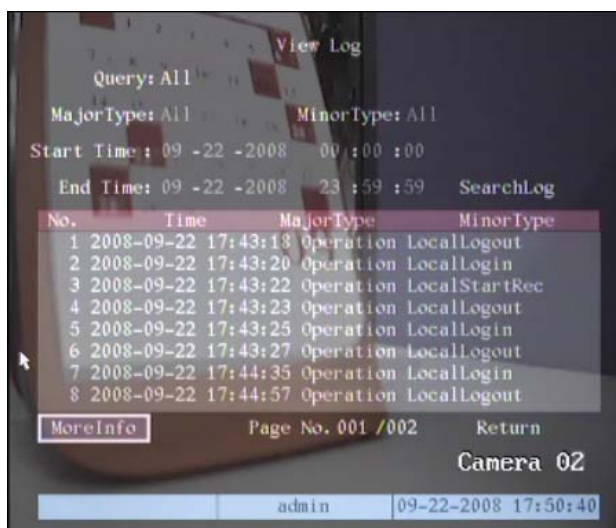

If you want to view the log based on default option, just press[ENTER]key. DVR will list all matched information. Also you can select options to search (By Type, By Date, By Type&Date).

By Type

View log information of the assigned type.

Type is divided into “Major type” and “Minor type”. Major type includes operation, alarm, exception and all.

For operation major type, there are many minor types, including Power On, Shut Down, Abnormal Shut, Panel Login, Panel Logout, Panel Config, Panel File Play, Panel Time Play, Local Start Record, Local Stop Record, Panel PTZ, Panel Preview, Panel Set Time, Local Upgrade, Net Login, Net Logout, Net Start Record, Net Stop Record, Net Start Transparent Channel, Net Stop Transparent Channel, Net Get Parameter, Net Config, Net get Status, Net Alert On, Net Alert Off, Net Reboot, BiComStart (Start Voice Talk), BiComStop (Stop Voice Talk), Net Upgrade, Net File Play, Net Time Play, Net PTZ.

For alarm major type, the minor type includes: External Alarm In, External Alarm Out, Motion Detect Start, Motion Detect Stop, View Tamper Start, View Tamper Stop.

For exception major type, the minor type includes: Video Signal Loss, Illegal Access, Hard Disk Error, Hard Disk Full, IP Conflict, DCD Lost.

For example: The steps of viewing alarm log.

Step 1: For “Query” item, select “By Type” to active “Major Type” and “Minor Type” items.

Step 2: For “Major Type” option, select “Alarm” option. For “Minor Type” option, select one of following options: All, External Alarm In, External Alarm Out, Motion Detect Start, Motion Detect Stop, View Tamper Start, View Tamper Stop .

Step 3: Move “Active Frame” to “Search Log” button, press[ENTER]key to start searching.

Step 4: When searching is finished, DVR will list all matched alarm information. In the list box, the information includes: Index, Occur Time, Major Type, Minor Type, Panel User, Net User, Host Address, Para. Type, Channel No, HDD No, Alarm In and Alarm Out. You can press “More Info” button for more information, also select page number to view more information.

Step 5: Press “Return” button back to “Utilities” menu.

By Time

View the log within one time period.

Step 1: Select “By Time” for “Query” option to active “Start Time” and “Stop Time” items.

Step 2: Input start time and stop time.

Step 3: Move “Active Frame” to “Search Log” button and press[ENTER]key to start searching.

Step 4: After finish searching, DVR will list the matched log information.

Step 5: Press “Return” button back to “Utilities” menu.

By Type&Date

View one kind of log in the assigned time period.

Step 1: Select “By Type&Time” for “Query” option to active “Major Type”, “Minor Type” “Start Time” and “Stop Time” items.

Step 2: Select “Operation” for major type and select one option for minor type.

Step 3: Input start time and stop time.

Step 4: Move “Active Frame” to “Search Log” button and press[ENTER]key to start searching.

Step 5: After finish searching, DVR will list the matched log information.

Step 6: Press “Return” button back to “Utilities” menu.

6.9 System Information

Press “System Info” icon in “Utilities” menu, you can get DVR system information, including Unit Name, Device Model, Serial Number, Firmware Version, and Encode Version.

Chapter7 Firmware Upgrade

The DVR firmware is stored in FLASH ROM. You can use DVR upgrade function to write the firmware file (digicap) into FLASH.

There are two cases that you need to upgrade DVR firmware. One is update old firmware. The other is when the code in DVR FLASH is crashed.

Note: Make sure that the DVR and the firmware are compatible before the upgrade.

7.1FTP Server Setup

You can download FTP server software through internet. Here we use wftpd32.exe as the example:

1. Run wftpd32.exe (FTP server software).

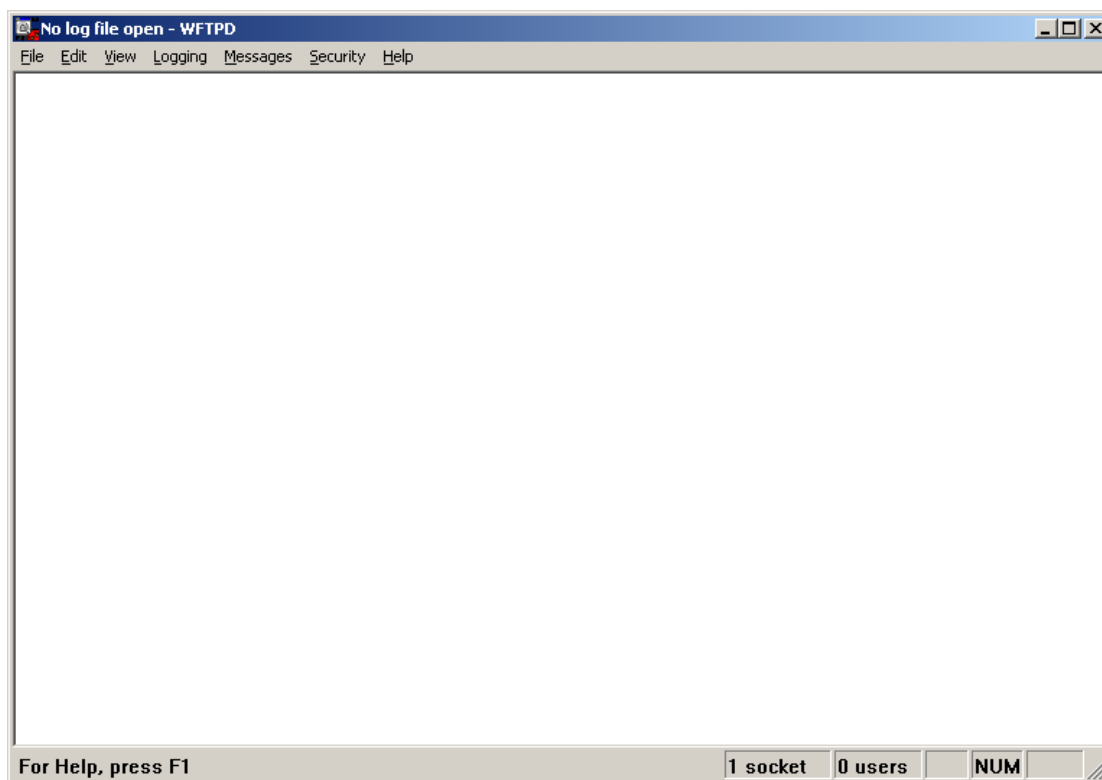

2. Select "Logging" in the menu, choose Log Options in the sub menu, and give the choice as follows:

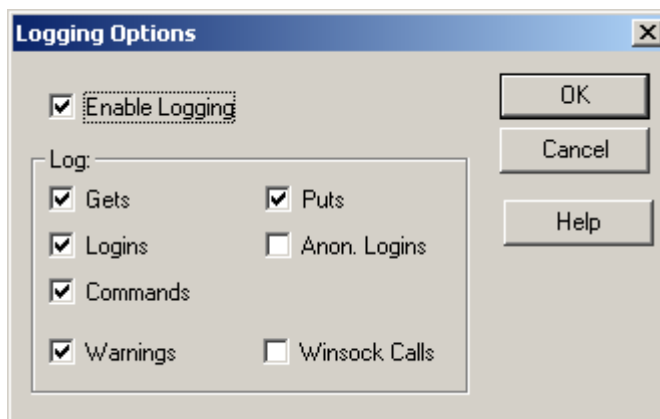

3. Select “Users/rights” under “Security” menu item. The following dialog box will be pop-up.



4. Create new user. Click “new user’. New user dialog pops up. Input user name “target”. Click “OK”.

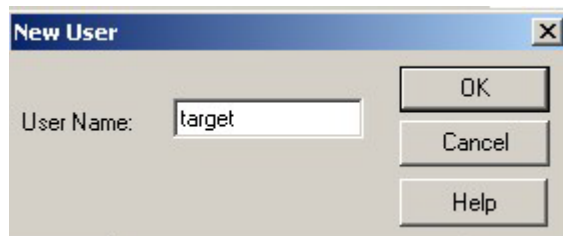

5. In the password dialog, input password “target” in “New Password” and “Verify Password” edit box. Click “OK” to save and exit the dialog box.

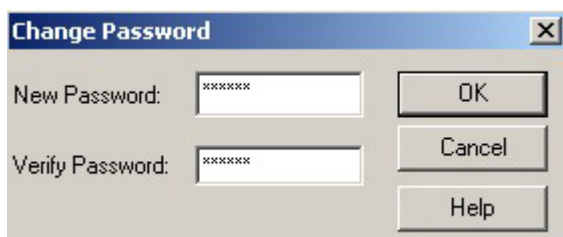

6. In the “User/Rights Security” Dialog, select “User Name” as “target”. In “Home Directory” edit box, input the path where the firmware file (digicap) is placed. Then press “Done” to exit.

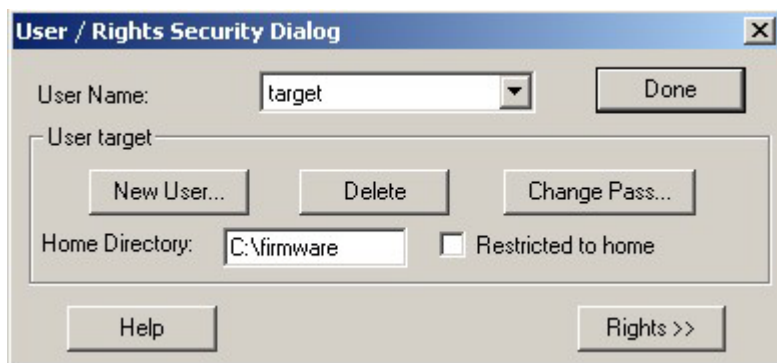

7. Next time, you need not setup again, just double click and open “wftpd32.exe” to upgrade the DVR/DVS firmware.

7.2 Upgrade Mode

1. Use client software to upgrade the firmware file. You do not need to use ftp server software. Please refer to the client software user manual for detail information.

Enter “Setup” → right click device name “remote configuration” → “ Update Remotely” Press Browse to import the path of firmware “digicap”, click “Upgrade” to start to upgrade.

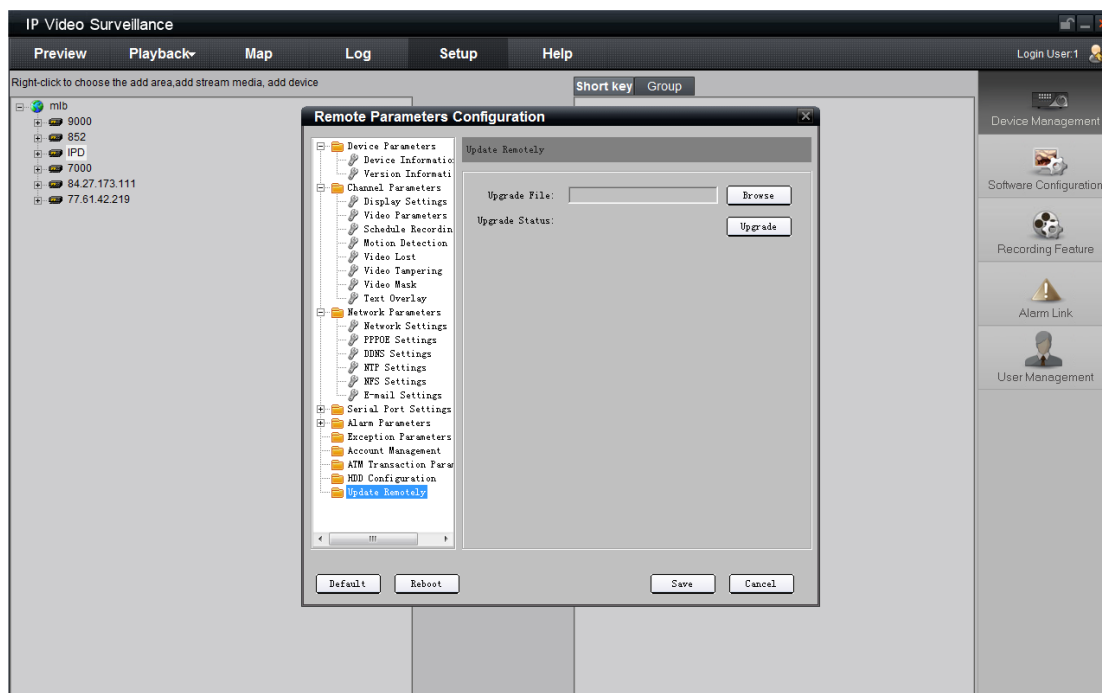

2. Use “FTP” function of “Upgrade” sub menu in “Utilities” menu. You need one host PC to run FTP server software and place firmware file (digicap), and make sure DVR and PC are in the same sub net.

1. In the “Utilities” Menu select “Upgrade.”
2. Input the FTP server IP address and press [ENTER].



Upgrading as follows:

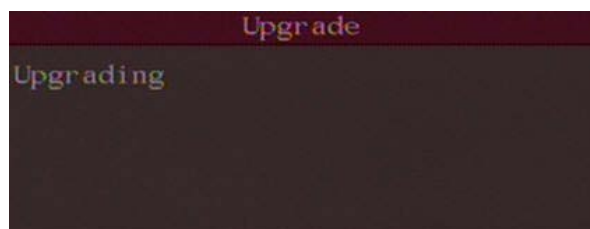

Note: Do not attempt any other tasks until the upload completes.

3. Use “USB” function of “Upgrade” sub menu in “Utilities” menu. The DVR will search for the upgrade firmware file in a connected USB FLASH, and update firmware. After upgrading successfully, DVR will ask you to reboot.



Note: Please make sure the firmware file (digicap) is placed under root directory of USB flash memory.

4. Upgrade from CD
 1. In the “Utilities” menu select the “Upgrade” button.
 2. In the popup dialog box select the CD button.



3. The DVR will search for the upgrade firmware file in a connected CD-ROM, and update firmware. After upgrading successfully, DVR will ask you to reboot.

Note: Make sure that the update firmware file is placed in the CD-ROM root directory.
5. After you reboot DVR, if you can only hear the startup sound, but can not see startup picture, you can input shell commands under HyperTerminal. You need one host PC to run FTP server and HyperTerminal software, and make sure DVR and host PC are in the same sub net. Please use DTE cable to connect DVR will host PC.
6. Use RS-232 serial command for upgrading.

Step 1: Setup and run HyperTerminal

The parameters are: Baud rate: 115200bps, Data bit: 8 bits, Stop bit: 1 bit, Parity: No, Flow ctrl: None.

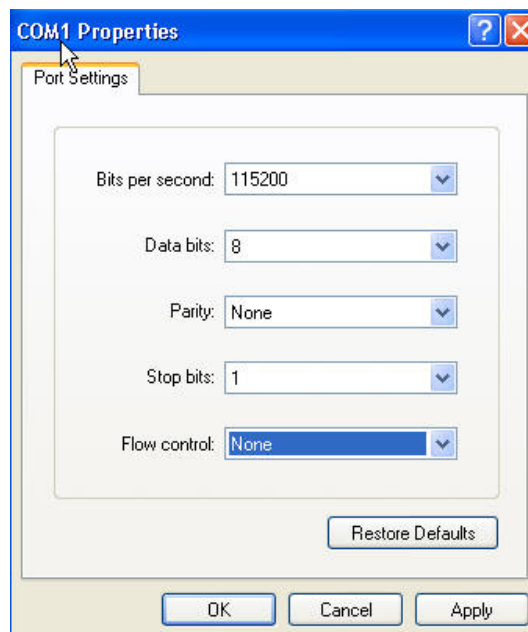

Step 2: Press "ctrl" and "u" keys of the PC keyboard. Do not release them.

Step 3: Switch off and on the power supply of DVRDVS. In the HyperTerminal, the following sentence is appeared: **Please input [u/U] or [ESC] key** Release "ctrl" and "u" keys.

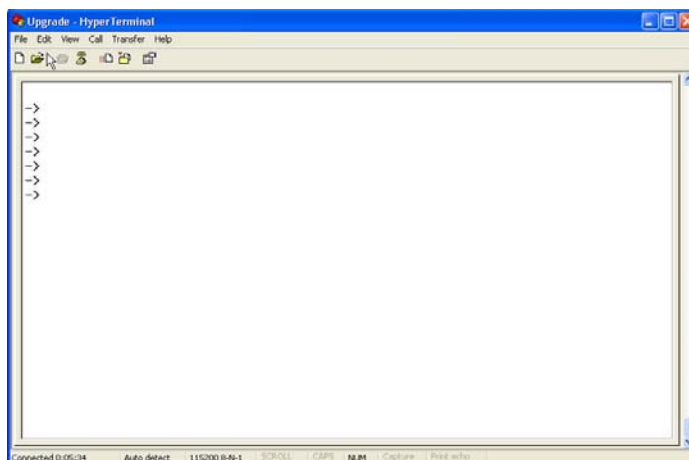

Step 4: Press “u” key. In the message line of “**IP address of NET DVR**”, input any one ip, just make sure DVR IP and FTP server IP are in the same sub net.

Step 5: In the message line of “**IP address of the FTP server**”, input the FTP server IP.

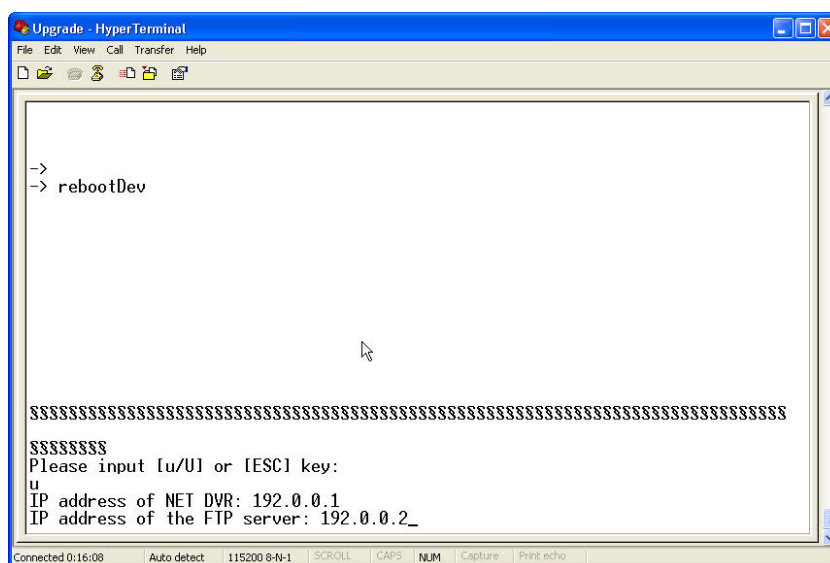

Step 6: In the message line of “**Confirm? (y/n)**”, press “y”. DVR will connect with that FTP server, and download the firmware file (digicap) through network. Please make sure FTP server and firmware file are setup and run correctly. After upgrade finished, press any key to reboot DVR.

Appendix A Mouse Control Function

1. Preview interface

Double-click the left key

1. Switch to the channel where the arrow at when viewing single picture.
2. Back to previous multi-pictures when double click again.

Scroll wheel forward

Switch to previous screen

Scroll wheel backward

Switch to the next screen

Single-click the right key

Pop up function menu including “Main Menu” “Single 1-16ch” “Multi Preview 4,9,12 or 16 Screen” “Next Preview” “PTZ Control” “Play” “Manual Record” and “Close Status”.

2. PTZ interface

Double-click the left key

Move to the center of the screen (For SAE\HIKVISION protocol)

Drag the left key

Select an area to zoom in (For SAE\HIKVISION protocol)

Scroll wheel forward

Switch to previous channel

Scroll wheel backward

Switch to the next channel

3. Channel name or OSD position configure interface

Drag the left key

A rectangle frame will be following with the cursor

Single click the right key

Pop-up menu, including Confirm, Cancel (and Style for OSD only).

4. Area configure interface

Right click

Pop-up menu including Confirm, Cancel, Clear, and Full (this option only appear in motion detect area configuration)

Drag the left key

Extend or shrink area

Press the left key and drag

Select an area for zooming in single playback interface

Moving

The primary grid will be following with the cursor

5. Test input interface

Click the left key

1. Pop up soft keyboard
2. Input text
3. Save and exit

Click the right key

Cancel the text and exit the edition

Scroll wheel forward or backward

Cursor goes to the previous or next character

6. Playlist interface

Click the left key

Select the file to copy or cancel

Scroll wheel forward

Select the previous file

Scroll wheel backward

Select the next file

Signal-click the right key

Cancel and return back to the preview interface.

Double-click the left key

Play the selected file

7. User interface

Double-click the left key

Enter the selected user's privileges setting interface

Single-click the right key

Cancel the operations you did and back to previous interface

Scroll wheel forward

Select previous user

Scroll wheel backward

Select next user

Appendix B HDD Capacity Calculation

Calculate total capacity needed by each DVR according to video recording (video recording type and video file storage time).

Step 1: According to Formula (1) to calculate storage capacity q_i that is the capacity of each channel needed for every hour, unit Mbyte.

$$q_i = d_i \div 8 \times 3600 \div 1024 \quad (1)$$

In the formula: d_i means the bit rate, unit Kbit/s

Step 2: After video time requirement is confirmed, according to Formula (2) to calculate the storage capacity m_i , which is storage of each channel needed unit Mbyte.

$$m_i = q_i \times h_i \times D_i \quad (2)$$

In the formula:

h_i means the recording time for each day (hour)

D_i means number of days for which the video shall be kept

Step 3: According to Formula (3) to calculate total capacity (accumulation) q_T that is needed for all channels in the DVR during **scheduled video recording**.

$$q_T = \sum_{i=1}^c m_i \quad (3)$$

In the formula: c means total number of channels in one DVR

Step 4: According to Formula (4) to calculate total capacity (accumulation) q_T that is needed for all channels in DVR during **alarm video recording (including motion detection)**.

$$q_T = \sum_{i=1}^c m_i \times a\% \quad (4)$$

In the formula: $a\%$ means alarm occurrence rate

Appendix C DVR Connect Cable Definition

1 UTP network connect cable made method

Material and tool

One twist cable (8 pin, the length can be defined as to the actual demand, but must be within 100m), 2 standard RJ45 head, one tool for RJ45.

Suggestion: have a network cable test tool to test each cable made.

Pin definition

To make the network cable according to the actual situation, there are two options:

(1) Use the following method to make the network cable when DVR is connected with network hub or switch.

1 (white-orange)	—————	(white-orange)	1
2 (Orange)	—————	(Orange)	2
3 (white-green)	—————	(white-green)	3
4 (blue)	—————	(blue)	4
5 (white-blue)	—————	(white-blue)	5
6 (green)	—————	(green)	6
7 (white-brown)	—————	(white-brown)	7
8 (brown)	—————	(brown)	8

The corresponding relationship of the direct cable

(2) Use the following method to make the cross network cable when DVR is directly connected with client-end PC.

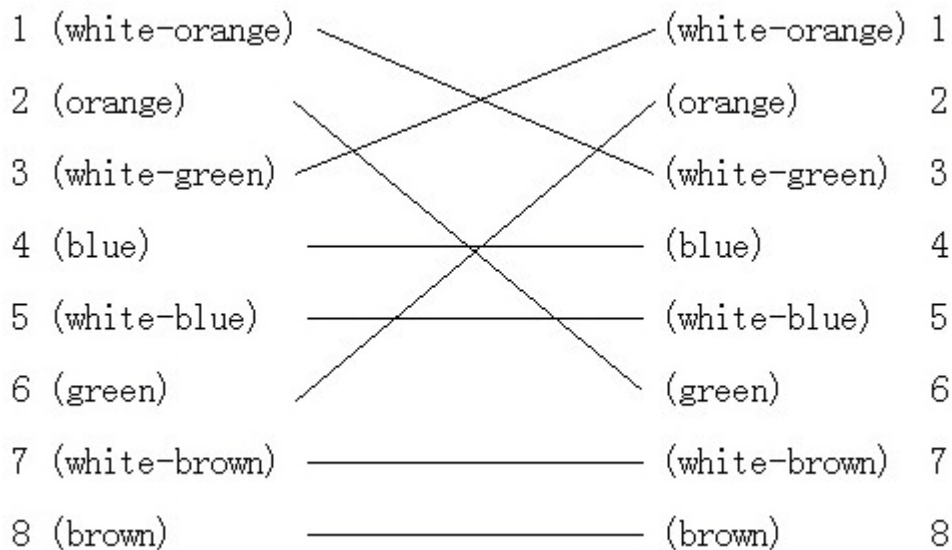

The corresponding relationship of cross cable

2 RS-232 connect cable made method

DS-7000HI-S has standard DB9 RS-232 interface, like PC COM port.

Pin definition

“I” means DVR input and O means DVR output.

Pin index	Name	I/O	Description
1	DCD	I	Carrier Detect
2	RXD	I	Receive Data
3	TXD	O	Transfer Data
4	DTR	O	Terminal Device Ready
5	GND		Ground
6	--	--	--
7	RTS	O	Request to Send
8	CTS	I	Clear Data

Appendix D Specifications

Model	DS-7004HI-S	DS-7008HI-S	DS-7016HI-S
Video compression	H.264		
Preview resolution	4CIF (PAL: 704*576, NTSC: 704*480)		
Playback resolution	4CIF/2CIF/CIF/QCIF	2CIF/CIF/QCIF	
Video input	4	8	16
Video input interface	BNC (1.0Vp-p, 75Ω)		
Video output	1 channel, BNC (1.0Vp-p, 75Ω)		
Video spot out	1 channel, BNC (1.0Vp-p, 75Ω)		
Video loop out	4	8	16
Frame rate (per channel)	4CIF: 8fps DCIF: 8fps 2CIF: 15fps CIF: 25(P)/30(N) fps	2CIF: 8fps CIF: 25(P)/30(N) fps	
Stream type	Video/Video&Audio	Video	Video/ Video&Audio(ch1-4)
Bit rate	32Kbps~2Mbps, user defined (Max. 8Mbps)		
Audio input	4	No	4
Audio input interface	RCA (2.0Vp-p, 1kΩ)	No	RCA (2.0Vp-p, 1kΩ)
Audio output	1 channel, RCA (Linear Electrical Level, 600Ω)	No	1 channel, RCA (Linear Electrical Level, 600Ω)
Voice talk	1 (Using 1 st channel of Audio IN)		1 (Using 1 st channel of Audio IN)
Audio compression	OggVorbis, 16Kbps	No	OggVorbis, 16Kbps
Communication interface	1 RJ45 10M/100M adaptive Ethernet Interface 1 RS232 interface (DB9) 1 RS485 interface (T+,T-,R+,R-)		
SATA interface	4 SATA interfaces, can max support 4 SATA HDD and each HDD can max support 2000GB, or 2 HDD and 1 SATA CD-RW/DVD-RW		
USB interface	1 USB interface can support USB disk, USB HDD, USB CD-RW/DVD-RW.		
VGA interface	1 VGA interface, supports resolution: 800*600/60Hz, 1024*768/60Hz		

	1280*1024/60Hz		
External alarm in	4	16	16
Relay output	2	4	4
Power supply	100~240VAC, 6.3A, 50~60HZ		
Power consumption	≤40W (without HDD or DVD-R/W)		
Working temperature	-10℃~+55℃		
Working humidity	10%~90%		
Size	440mm(W)*390mm(D)*70mm(H)		
Weight	≤8Kg (without HDD or DVD-R/W)		

PAL: 176*144(QCIF), 352*288(CIF), 704*288(2CIF), 528*384(DCIF), 704*576(4CIF);

NTSC: 176*120(QCIF), 352*240(CIF), 704*240(2CIF), 528*320(DCIF), 704*480(4CIF).

Appendix E List of Recommended DVR Peripherals

HDD:

1. IDE HD

Maxtor:

1. DiamondMax Plus 9 80G ATA/133 HDD
2. DiamondMax Plus 9 160G ATA/133 HDD
3. DiamondMax Plus 9 200G ATA/133 HDD
4. MaxLine Plus I 250G ATA/133 HDD
5. MaxLine I 300GB ATA/133 HDD
6. MaxLine II 300GB ATA/133 HDD

Seagate:

1. Barracuda 7200.7 40G
2. Barracuda 7200.7 80G
3. Barracuda 7200.7 120G
4. Barracuda 7200.7 160G
5. Barracuda 7200.7 200G

Seasu:

1. WD 400 (40G)
2. WD 800 (80G)
3. WD 1200 (120G)
4. WD 2000 (200G)
5. WD 2500 (250G)

Samsung: 160G SP1604N REV.A

Note: 160G SP1604N REV.C are not supported at present

2. SATA HD

Maxtor

1.160G

DiamondMax 10

Model:6L160M0 160GB SATA150 HDD

2.250G

MaXLine Plus II

250GB SATA/150 HDD

3.80G

DiamondMax 10

Model:6L080M0 80GB SATA150 HDD

Seagate

1. Barracuda 7200.8 250G (+5V +12V 0.46A 0.56A)
Model:ST3250823AS
2. Barracuda 7200.9 200G (+5V +12V 0.46A 0.56A)
Model:ST3200827AS
3. Barracuda 7200.9 160G (+5V +12V 0.46A 0.56A)
Model:ST3160812AS
4. Barracuda 7200.7 120G (+5V +12V 0.63A 0.74A)
Model:ST3120827AS
5. Barracuda 7200.9 80G (+5V +12V 0.46A 0.56A)
Model:ST3808110AS
6. 500G
7. 700G
- 8 Seagate SV35.1 250G SATA
ST3250824SV
9. Seagate SV35.1 500 Gbytes (+5V +12V, 0.46A 0.56A)
ST3500641SV
P/N:9CS148-501
Firmware:3.01
10. Seagate SV35.2 250 Gbytes (+5V +12V, 0.52A 0.72A)
ST3250820SV
P/N: 9DC13E-901
Firmware: 3.ACE
11. Seagate SV35.2 320 Gbytes (+5V +12V, 0.72A 0.52A) SATA
ST3320620SV
P/N:9DC14G-901
Firmware:3.ACE
12. Seagate SV35.2 500 Gbytes (+5V +12V, 0.52A 0.72A)
ST3500630SV
P/N: 9DC146-901
Firmware: 3.ACE
13. Seagate SV35.2 750 Gbytes SATA (+5V +12V, 0.52A 0.72A)
ST3750640SV
P/N: 9DC148-901
Firmware: 3.ACE
14. Seagate SV35.3 250G
ST3250310SV
P/N:9FD132-901
Firmware:3.ACC

Seasu

1. WD Caviar SE

- WD 2000 (5VDC 12VDC 0.92A 0.90A)
MDL:WD 2000JS-00MHB1
- 2. WD Caviar SE16
WD 2500 (5VDC 12VDC 0.92A 0.90A)
MDL:WD 2500KS-00MJB1
- 3. WD Caviar SE
WD 1600JS (5VDC 12VDC 0.92A 0.90A)
MDL:WD 1600JS-00MHB0
- 4. WD Caviar SE
WD 1200JS (5VDC 12VDC 0.92A 0.90A)
MDL:WD 1200JS-00MHB0
- 5. WD Caviar SE
WD 800 (5VDC 12VDC 0.45A 0.50A)
MDL:WD 800JD-75MSA1

The West Data

- 1. WD1600YS WD Caviar RE16
MDL: WD1600YS-01SHB0
- 2. WD2500YS WD Caviar SE16
MDL:WD2500YS-01SHB0
- 3. WD3200YS WD Caviar RE16
MDL:WD3200YS-01PGB0
- 4. WD4000YS WD Caviar RE2
MDL:WD4000YS-01MPB0
- 5. WD5000YS WD Caviar RE2
MDL:WD5000YS-01MPB0
- 6. WD4000YR WD Caviar RE2
MDL:WD4000YR-01PLB0

Samsung

- 1. HA500LJ/CE
- 2. HA751LJ

Others

- 1. WD2500YS WD Caviar SE16
MDL:WD2500YS-01SHB0
- 2. WD4000YR WD Caviar RE2
MDL:WD4000YR-01PLB0
- 3. Seagate DB35.1 250G

USB disc (FAT32 format)

- 1. Aigo The king of Motion Storage (the second generation) Intelligent security mode, 40G.

2. PC HD + ydstar's transfer box.
3. IBM 20G, 30G.
4. Newsmy traveler 2.5T 40G.

U Flash Memory (FAT or FAT32 format)

The following products are supported:

1. Thunis USB2.0 512M
2. NETAC super stable and classic mode 64M,32M
3. NETAC high speed without Driver mode 64M
4. NETAC buildup without Driver(upgrade) mode 32M
5. NETAC U200 128M(Flash memory)
6. Aigo mini king recorder mode MP3—H06 128M
7. Aigo mini king recorder mode 128M
8. (Supported after the modification of software on 2005-1-4.)
9. RUNDISK RM-UR03 128M
10. SMART 128M
11. Babydisk King of SM 64M (HEDY)
12. Samsung 64M
13. Newsmy Flash Memory 32M
14. CoDisk 64M
15. caixing 128M
16. DELL 128M
17. Kingston USB2.0 1G
18. Thunis USB2.0 512M
19. Thunis USB2.0 256M
20. Hanxin High-speed King USB2.0 512M
21. Hanxin High-speed King USB2.0 256M
22. DATA USB2.0 128M
23. Dallmeler USB2.0 JetFash 64.
24. Dell 128M (Note: If can not back up at first, please restart the DVR)
25. Aiwa MP3 AW-33-128 128M

The following products are **not supported:**

1. Aigo Mini king. The second New and Sharp Generation 256M
2. Old longwing technology 128M
3. BenQ MP3 Joybee 102 256M

USB CD-R

- 1.Aigo: ydstar,ME-335U2
- 2.BENQ Outside Recorder 5232WI-ok2
- 3.aigo F5232BU
- 4.ASUS CRW—4824A + ydstar's USB transfer box

5. sony + ydstar's USB transfer box
7. SONY CD-R/RW CRX230AD + transfer wire
8. SONY CD-R/RW CRX225E + transfer wire
9. BENQ Outside Recorder EW162I-OK210
10. BenQ (CD) Mode: 5232WI
11. BenQ (CD/DVD) Mode: EW164B
12. Samsung (CD/DVD) Mode: SE-S164
13. LG (CD/DVD) Mode: GSA-E10L

IDE CD-R

1. Sony CD-R/RW CRX225E
2. NEC DVD R/RW & CD-R/RW ND-3500A
3. Toshiba Samsung CD-RW SH-R522

V1.6&V2.0 can use the following CD-R Mode:

- 1、 LG DVD (USB) GSA-E10L
- 2、 Samsung DVD (USB) SE-S164
- 3、 Asus DVD (IDE) DRW-1608P3S
- 4、 Samsung DVD (IDE) TS-H652
- 5、 LG DVD (IDE) GSA-H12N
- 6、 BenQ DVD (IDE) DW1670
- 7、 BenQ DVD (IDE) DW1680
- 8、 Sony DVD (IDE) DW-Q120A
- 9、 Sony DVD (IDE) DW-G120A
- 10、 LG DVD (IDE) GSA-H20L

SATA interface (are suitable for -S models) :

1. Pioneer DVR-212CHG
2. Samsung TS-H653
3. Panasonic SW-9588-C
4. Sony AW-G170S

Appendix F Quick Search Function Table

Type	Name	Description	Index
Safety function	User management	Create and delete users. System has one default administrator. The administrator can create 15 users and define their rights.	5.2
	Password Management	Modify password.	4.3&5.1
HDD recording	HDD management	Format HDD, HDD information.	6.4
	Recording mode	Manual record, All time record, Motion detection record, Alarm record, Motion&Alarm record, Motion Alarm record.	5.12
	Recording para.	Bit rate, Frame rate, Image quality etc	5.12
	Playback	Playback by time, Playback by file. Fast, Slow, Pause, Frame by frame. 2-ch synchronized.	4.6
	Backup	Backup record files and video clips.	4.7
Local monitoring	Preview mode	Monitor and VGA display. 1 screen/4 screen/9 screen/16 screen preview mode. Auto switch or manual switch.	5.11
	PTZ control	Control pan, tilt, zoom, focus and iris. Setup and adjust preset, sequence and cruise.	4.4
	Motion detection	Motion detect area, sensitivity and response policy setup.	5.10
	Alarm input	Alarm input response policy, schedule setup.	5.13
	Relay output	Alarm output parameters setup.	5.13
	Mask	Sensitive mask area setup.	5.7
	View tampering	Camera spiteful block setup.	5.8
	Exceptions	Exception response, such as HDD error, HDD full, illegal access, etc.	5.17
	Camera status	Recording, video loss status display.	4.2
Network	ASDL	Using PPPoE dialup function supports DNS.	5.14
	Preview	TCP, UDP, RTP, Multicast.	*
	Control	Control DVR through network.	*
	Alarm	Send alarm information to host PC through network.	5.14
	PTZ control	Remote control PTZ.	*
	Remote setup	Remote setup DVR parameters.	*

	Remote record	Remote record real time stream.	*
	Remote playback	Remote playback the recorded files in DVR	*
	Download	Download recorded files in DVR.	*
	Remote upgrade	Remote upgrade firmware.	*
	Transparent channel	Remote control serial device connected with serial port of DVR.	5.16
	Web	Using IE to access DVR	*
	PSTN	Access DVR through PSTN.	5.16
Utilities	OSD	OSD setup	5.5
	LOGO	Logo setup	5.5
	View log	View log	6.8

[*Note]The network SDK and client demo source code are included in attached CD.

Appendix G Troubleshooting

Failure	Possible reasons
After plugging in power, turning on the power switch, "POWER" light in front Panel does not turn on, and fan does not work.	<ol style="list-style-type: none"> 1) Power cable is broken. 2) Power supply is broken.
After plugging in power, turning on the power switch, "POWER" light in front panel turn to green while fan does not work.	<ol style="list-style-type: none"> 1) Front panel cable is broken. 2) Fan is broken.
After plugging in power, turning on switch, "POWER" light turn to green, the indicator lights in the panel turn on at the same time, but fan does not work.	The ATX plug in main board is not well plugged in.
DVR continuously reboots after start up, and makes a sound like "ticktack" every 10 seconds.	<ol style="list-style-type: none"> 1) Upgrade the wrong firmware 2) Compression board has problems. 3) Main board has problems.
There are no images in the monitor connected with VOUT after DVR is started.	<ol style="list-style-type: none"> 1) The cable connected with the monitor is broken. 2) Real board of DVR has problems. 3) Main board of DVR has problems.
Cannot find the hard disk in reboot process.	<ol style="list-style-type: none"> 1) Hard disk cable is broken. 2) The power cable of hard disk is not connected. 3) Hard disk is broken.
No reponse in HyperTerminal interface.	<ol style="list-style-type: none"> 1) Baud rate is not matched. 2) RS-232 cable is broken. 3) Serial port of PC is broken. 4) RS-232 port of DVR is broken.
DVR can not control PTZ through RS-485 port.	<ol style="list-style-type: none"> 1) RS-485 cable is not connected correctly or broken. 2) PTZ parameters error. 3) RS-485 port of DVR is broken.
Client software can not view DVR live image.	<ol style="list-style-type: none"> 1) Network is error. 2) Connect wrong DVR (wrong IP, port number, username or password, ect).

	3) Old player SDK (playm4.dll)
--	--------------------------------

Notes:

- 1) Place the DVR in well ventilated space so that it operates within the allowed range of temperature and humidity as in specification.
- 2) If the circuit board is wet, dust on circuit board can cause a short circuit. The circuit board, plug and socket, housing fan and housing should be cleaned by brushing regularly.

Appendix H Product Service

Thank you for choosing our products.

All of our products users can enjoy a conditional free repair guarantee service for hardware within 12 months starting from purchase date, and a free exchange service within one month (valid for the damage caused by non personal acts). Permanent upgrading service is provided for the software.

Liability Exclusions:

Any product malfunction, abnormalities in operation or damage caused by following reasons are not within the free service scope of our company. Please select payable service.

(1) Equipment damage caused by improper operation

(2) Improper environment and conditions in/on which the equipment operates, e.g., improper power, environment temperature, humidity and lightening strike etc. that cause equipment damage.

(3) Force damage, e.g., earthquake and fire etc. that cause equipment damage.

(4) Equipment damage caused by the maintenance of personnel unauthorized by our company.

(5) Product sold 12 months ago.

In order to provide various services to you, please fulfill relevant registration procedure provided by us after you purchase the product. Cut off User's Information Card and fax or post it to us after the card is filled in.

Address:

Post Code:

Fax:

Appendix I Customer Information Card

User's Name		M
	r./Mrs.	
Company Name		
Post Address		
Postcode		
Phone Number		
E-mail		
Model Number of Product		
Serial Number of Product		
Purchase Date		
Distributor		

Suggestions:

